

7.0 CONCLUSION

In reaching a conclusion, the following factors need to be considered:

- This is an unusually constrained site with a wide variety of constraints present.
- Inclusion of the MEW as part of project carries substantive additional risk to the overall programme.
- Assessment of planning permission durations should be conducted on a risk adjusted basis to reflect the characteristics of that specific project.
- While Dublin Central will deliver the MetroLink Enabling Works, many of the risk factors that could impact it are out of the control of Dublin Central (e.g., TII forcing design changes, delay to getting an enforceable Railway Order etc).
- Material MEW programme delays will effectively run down the clock for Dublin Central to be able to complete the over-site works. Such occurrences have the potential to result in the development not being complete within the lifetime of the permission. This would present an intolerable risk to the viability of the scheme.

Therefore, the proposed planning duration:

- Must consider likely risks that could occur while avoiding the outcome of having a development that cannot be completed within the lifetime of the permission.
- Must not equate to the targeted programme for delivery which represents a faster delivery period and, which by its nature does not have all the likely project risks factored in.
- Must not be merely a 'pessimistic date', but rather a genuine assessment of what a prudent developer may require in the context of the project specific risks and constraints.

For these reasons Dublin Central GP Ltd believes the 15-year Planning duration applied for is the correct and most appropriate period.

While an Alternative Approach for delivery within 12 years has been discussed within this report, it is considered sub-optimal with a variety of spill over impacts on the surrounding environment. While there are clear programme benefits, in totality, it is not considered the preferred approach.

Appendix D - SUPPLEMENTAL PROGRAMME STATEMENT for Dublin Central GP Ltd dated 18th July 2022 – The Certo supplemental programme statement issued to An Bord Pleanála in support of its first party appeal justifying why a 15 year planning duration for Site 5 is necessary and why the 7 year period granted is wholly inadequate.



DUBLIN CENTRAL MASTERPLAN SUPPLEMENTAL PROGRAMME STATEMENT

for Dublin Central GP Ltd

18th July 2022

CERTO

Management Services

1. PURPOSE OF THIS STATEMENT

The purpose of this statement is to provide additional detail with respect to the key rationale behind the Dublin Central GP Ltd. application to Dublin City Council for a 15 year duration of planning permission for Site 5 and its continued firm belief that such a duration is imperative to the expeditious and successful delivery of the Dublin Central project.

While the Applicant welcomes the Dublin City Council decision to grant permission for Site 5 (Planning Ref: 2863/21), dated 23rd June 2022, the 7 year duration conditioned is considered to be wholly inadequate in this instance.

2. CONTEXT

GENERALLY

Dublin Central GP Ltd. lodged a planning application to Dublin City Council on 1st June 2021 for the redevelopment of Site 5 (Planning Ref: 2863/21) as a component part of its overall Dublin Central Masterplan.

The site comprises the following:

Site 5 – offices with café / restaurant at ground floor level overlooking the new square

The overall areas of the proposed development of the Overall Site are quoted in Table 1.

	Site 1	Site 2AB	Site 2C	Site 3	Site 4	Site 5	Total
	sq. m	sq. m	sq. m	sq. m	sq. m	sq. m	sq. m
Office	3,610	17,484	17,029	-	295	5,799	44,217
Hotel	8,094	-	-	7,175	-	-	15,270
Residential	-	-	-	6,452	1,454	-	7,906
Retail	-	1,876	1,255	1,954	617	-	5,672
Café / Restaurant	-	625	150	138	864	679	2,456
Cultural / Gallery / Cafe	-	-	-	123	-	-	123
Extension to National Monument for ancillary use to National Monument – a cultural facility	-	-	-	-	60	-	60
Metrolink Enabling Works	-	555	831	-	-	-	1,386
Total	11,704	20,541	19,235	15,842	3,290	6,478	77,090

Note: the areas given for Site 1, Site 2AB and Site 2C are based on draft calculations prepared for intended applications for permission. The areas given for Sites 5 are included in the applications for permission made.

Table 1 – Schedule of Area for the Masterplan of the Overall Site.

A 15 year duration was sought, in the knowledge that 5 year durations are typical for commercial developments in the city centre and therefore a clear rationale to justify the longer duration being sought was included. This justification was included within the *Programme Report*, prepared by *Certo Management Services* contained in Appendix A of the *Masterplan Outline Construction Management & Demolition Plan*, prepared by *Waterman Moylan Consulting Engineers*, submitted as part of the Site 5 planning application (also appended herewith).

Such an extended duration is required by the requirement for Site 5 to be demolished to provide critical site access and a construction compound in order to enable the sequential and logical delivery of the Dublin Central Masterplan, most notably, Dublin Central Site 2 which includes substantive oversight development and enabling works to facilitate the future O’Connell Street MetroLink station as part of these proposals.¹

¹ The Applicant intends to lodge the Site 2 application imminently.

WHY WAS A 15 YEAR DURATION APPLIED FOR?

An extract from the *Programme Report* (May-21) is shown below in Figure 1.

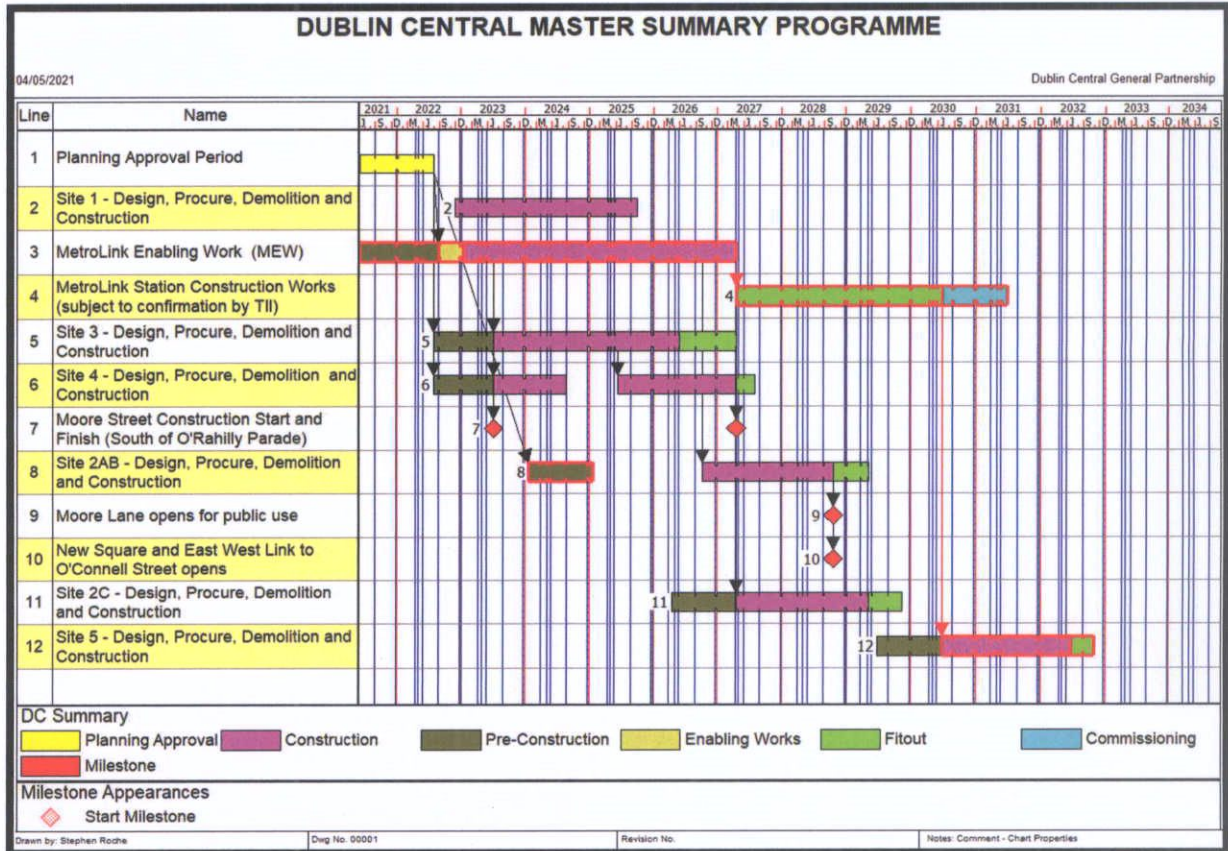

Figure 1 – Master Summary Programme (May 2021)

As can be seen in Figure 1, the works for Site 5 are timed to commence (Summer 2030) only once the oversite works in Site 2AB and 2C are completed (Autumn 2028 and Spring 2029 respectively)². It is further envisaged that the construction and fitting out of the MetroLink Station at a later date (between Summer 2027 and Summer 2030), by third parties and subject to a Railway Order, will also require access via Site 5, a process for which the Applicant has no certainty at this juncture.

At the time of writing, the *Programme Report* (May-21), concluded that TII³ would need space at street level to facilitate the construction of a future station, subject to its Railway Order. Some of the major plant and equipment may be deliverable via the tunnels, but there will always be a need for a compound to feed into Site 2 and elsewhere. The *Programme Report* provided for these additional requirements in seeking a planning approval period of 15 years.

Since writing the *Programme Report* (May-21), further detailed coordination has occurred with TII concerning its approach to fitting out of a future station and coordination of same with the Applicant’s development, following the completion of the Applicant’s Site 2 works.

² Subject to a separate application by the Applicant that will include enabling works for Metrolink to be undertaken on behalf of TII.

³ Transport Infrastructure Ireland.

The MetroLink Enabling Works (MEW), as its name suggests, relate only to preliminary works to facilitate a future MetroLink station, which itself will be subject to a Railway Order by TII. The MEW will be undertaken by the Applicant, subject to a separate planning application (Dublin Central Site 2 application due to be submitted imminently). The eventual construction of a station by TII, will involve substantive works including major internal civil works including the construction of mezzanine level floor slabs, railways and ancillary infrastructure, rail platforms, internal walls, lining walls, stairs and civil works for escalators and other elements followed by the mechanical and electrical installation works. It is expected that the civil works will require space to receive and handle materials and plant at grade to be then delivered to the work area below grade.

In addition, large items of M&E equipment will be delivered and handled in Area 1 as noted in Figure 2 before taking them into the building and dropping them down the access shaft referred to as Access Point 1. The items of equipment that will need to be handled include:

- escalators,
- ventilation fans,
- attenuators / dampers / transitions,
- VSD's / vent control equipment,
- heating, ventilation, air-conditioning (HVAC) / air handling units (AHU's),
- HV transformers,
- HV switchgear,
- traction power equipment,
- lifts,
- HV/LV switch panels,
- cabling (drums),
- ladder rack,
- pipework,
- pumps,
- communications/IT/ticketing/signalling, and
- steelwork

The strategy that TII has outlined for the logistics of delivering the station construction involves the use of Site 5 as can be seen in Figure 2 which is an extract from the TII document entitled "*METROLINK REPORT O'Connell Street Station – Review of Main Works Contractor's Works after Developer Constructed Box and Over Site Development Construction*" that was shared with Dublin Central GP Ltd. in February 2022.

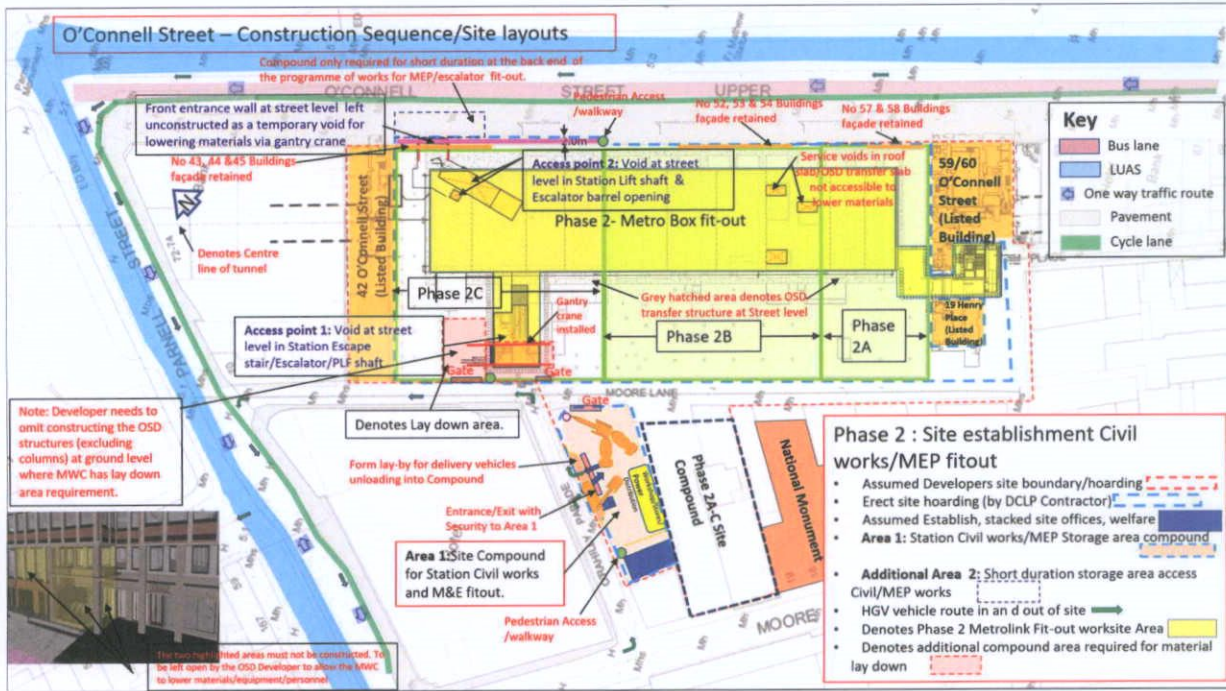

Figure 2 – Extract taken from the TII Review of Main Works Contractor's Works after Developer Constructed Box and Over Site Development Construction (included with permission from TII)

This clear intention to use Site 5 to assist with the construction of the station had been anticipated when the Planning Application for Site 5 was made, and a planning duration of 15 years was requested. Site 5 will be held back to support the construction of Sites 2AB and 2C and the station.

In preparation of the Site 5 Planning Application, allowance was also made for unforeseen issues / constraints which any prudent plan would have in its programme. Delays to the construction of the MEW brought about, for example, by a delay in achieving an enforceable Railway Order (amongst others), will have a knock on impact on the delivery of Site 5, particularly as Site 5 is the final phase of the masterplan to be developed according to the Applicant's construction phasing strategy (Refer to Figure 3). Such provisions have been considered in the next section of this Statement and summarised in Figure 4 below.

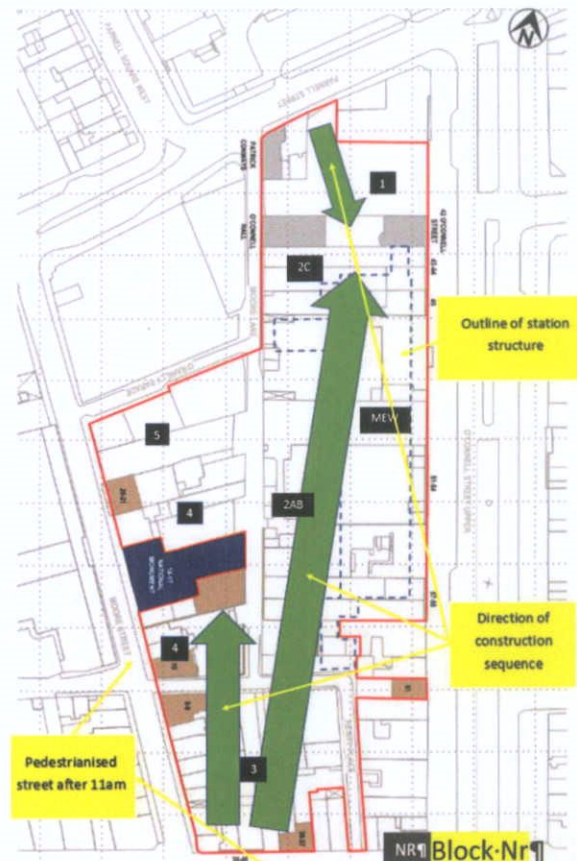

Figure 3 – Extract taken from Programme Report showing direction of construction approach

The significance of Site 5 in the delivery of the Overall Site play a crucial role, as it:

- Ensures disruption to the rest of the locality is minimised
- Manages traffic distribution to and from the Overall Site
- Reduces the need to encroach onto O'Connell Street with construction activity
- enables a logical south to north construction sequence that enables a quicker release of public areas back into public use (see Figure 3)
- Helps protect the National Monument at Nos. 14-17 Moore Street by giving the necessary "breathing space" to allow construction to be managed around it
- Facilitates the approach to minimise the disruption to the Moore Street Market Traders during the works

With the grant of a seven year permission by Dublin City Council (June 2022), the key benefits outlined above which have been carefully considered within construction strategy by Dublin Central GP Ltd. (informed by detailed dialogue and co-ordination with TII) are completely undermined. This will result in greater pressure being placed on the surrounding streets and on local stakeholders.

DCC PLAN NO 5126/22
RECEIVED: 26/10/2022

3. MONTE CARLO SIMULATION

The above factors have been given consideration in determining the proposed planning durations on a risk-adjusted basis.

Potential constraints were assessed by applying impact and probability criteria to predict an estimate for an overall delay. Modelling the data is helpful in determining how the overall impact upon the critical path (longest duration) could be assessed considering that:

- a) Not all risks will affect the critical path of the project as they could affect works not on the critical path at the time.
- b) As risks occur, not all will affect the critical path as some will be concurrent with other more dominant risks and therefore it is the dominant risk time that will be lost, and so it is this that needs to be modelled to predict the longest path for the project.
- c) Not all risks may be realised, and some may only be partly realised.

To account for the items a) to c) above, and to more accurately predict the impact on the critical path (longest duration) the project was modelled using computer software which ran a defined number of Monte Carlo simulations to predict the probability of different outcomes given the intervention of the risk variables present. This simulation is a construction industry standard approach that is typically employed for large scale, complex development projects. This modelling helped inform the impact of risk and uncertainty when deriving the completion dates for all the various Sites, as can be seen in Figure 4 below.

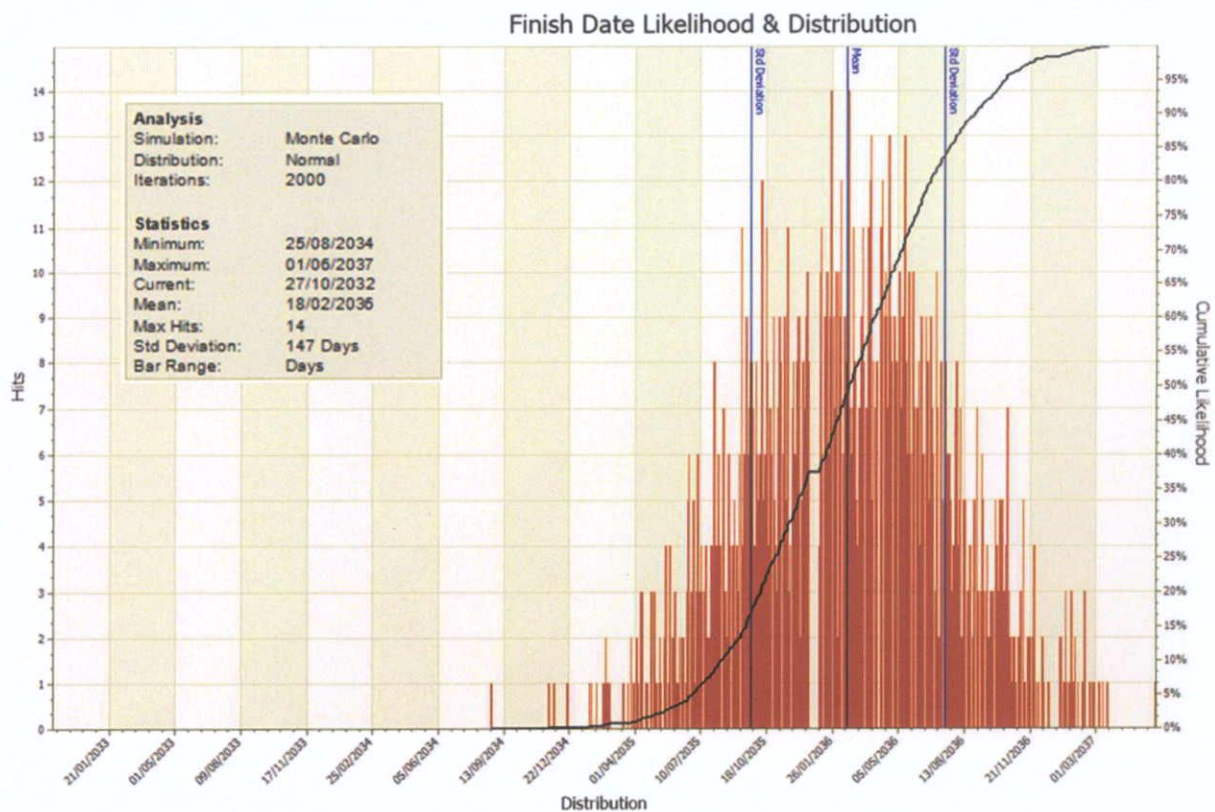

Figure 4 – Monte Carlo simulation for longest path of total project

To understand the effect on the completion dates of all the Sites, it was necessary to consider the predicted programme for any given percentile of probability and compare this to the Baseline Programme. Two different percentiles were used for this exercise to determine how sensitive the difference might be. Because this exercise is being applied to determine the correct duration of the Planning Approval period to be applied for, an extremely high percentile of probability was considered necessary and therefore the two percentile values that were used were 80% and 100%. The 80% percentile assumes that most of the predicted risk events have been realised, but not all of them to their fullest degree, whereas the 100% percentile predicts the most likely statistical outcome for the worst case situation.

The results can be seen in the Gantt Chart in Figure 5. The "Hatched Green" bars broadly show the baseline programme (shown in Figure 1) before the analysis was applied. The "Yellow" bars show the first position, i.e., the 80% percentile that the sites will be completed by the dates shown with the "Solid Dark Green" bars showing the second position, i.e., the 100% percentile.

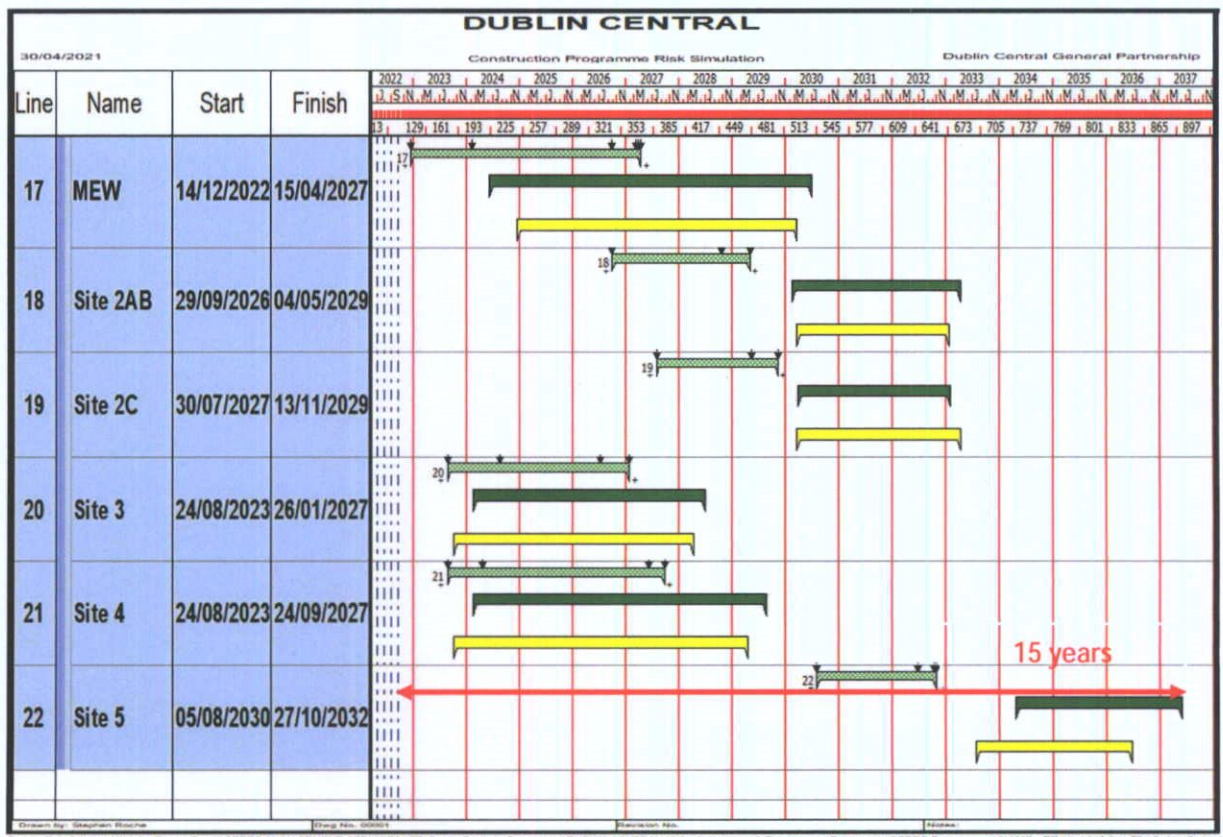
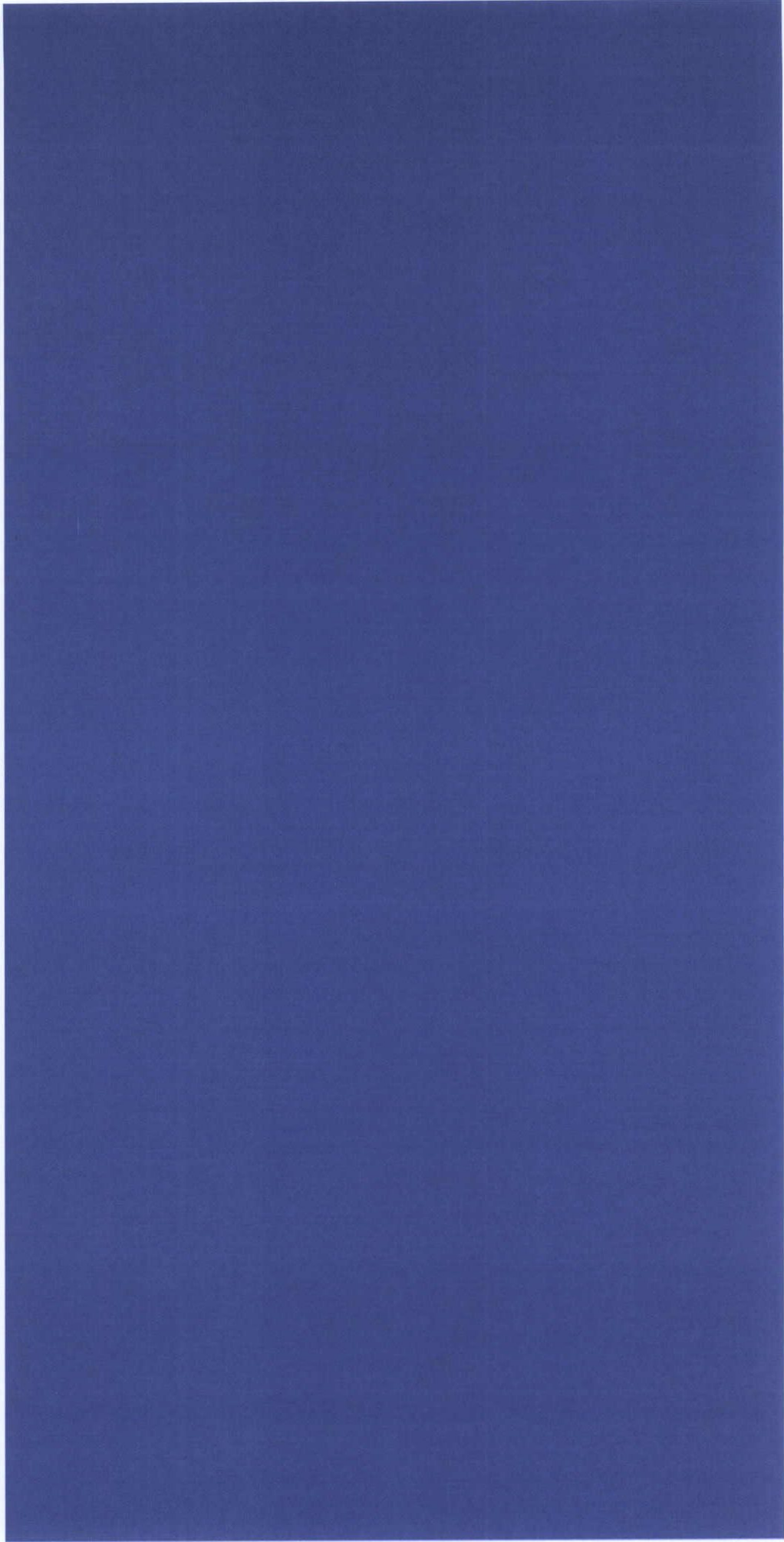

Figure 5 – Monte Carlo 80% and 100% percentile modelling results

The modelled completion date for Site 5 shows a 15 year duration is necessary.



Appendix E – MetroLink latter dated 20th July supporting the appeal to change the Planning Duration from 7 years to 15 years to accommodate their needs

An Bord Pleanála
64 Marlborough Street
Rotunda
Dublin 1
D01 V902

By email

Dáta | 20th July 2022

Ár dTag | Our Ref. CAP_ML_L0264

**ABP Ref: 313947-22. Dublin City Council Planning Register Reference: 2863/21
Proposed Dublin Central Development, O'Connell Street, Dublin 1**

Dear An Bord Pleanála

We refer to the First Party Appeal submitted by the applicant Dublin Central GP Limited under the above ABP reference (the **Appeal**). The Appeal is against condition 5 only which provides for a seven year duration.

The Appeal seeks to have substituted for that seven year duration a duration of 15 years.

We confirm having reviewed the Appeal documentation which makes a number of statements about the potential length of the construction programme for Site 5. As you will be aware, TII will shortly be submitting a Railway Order application for the MetroLink Project. One of the MetroLink stations will be located underneath Dublin Central GP Limited's proposed development on O'Connell Street. We confirm that the statements made in the Appeal relative to there being a requirement to continue to use "Site 5" to access the station box during its construction and fit-out are correct.

For those reasons, I wish to confirm that TII is fully supportive of the Appeal and respectfully requests that the Board grant a 15 year duration under this planning permission.

Yours faithfully

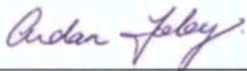

Aidan Foley

Project Director – MetroLink

Cc:

- Hugh Creegan - Deputy Chief Executive, National Transport Authority
- Nigel O'Neil – Director of Capital Programmes
- Paolo Carbone – Head of Public Transport Capital Projects

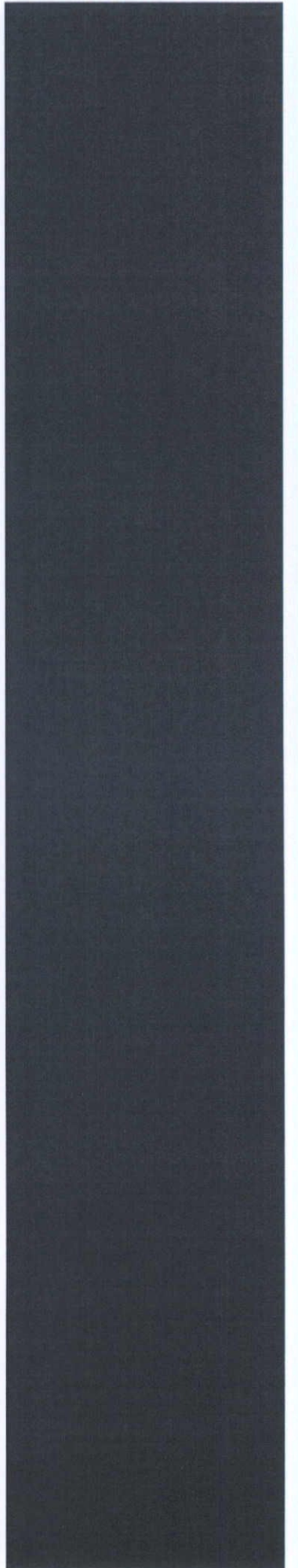
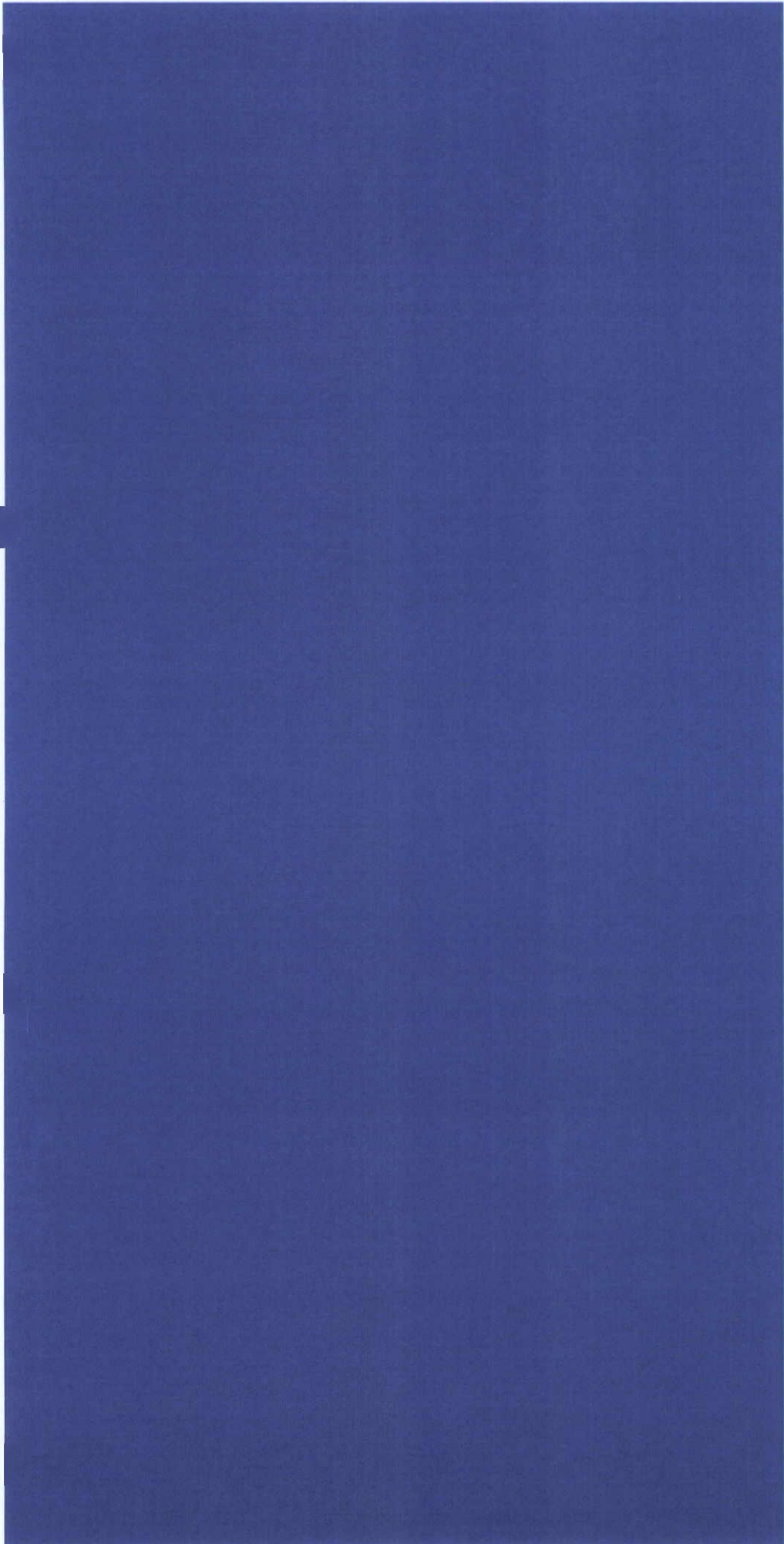

UK and Ireland Office Locations



Dublin Central

Project Number: 19-021

Document Reference: DC-WAT-XX-XX-RP-C-001010

APPENDIX 3.2

**OUTLINE CONSTRUCTION & DEMOLITION MANAGEMENT PLAN –
SITE 2**

DCC PLAN NO 5126/22
RECEIVED: 26/10/2022

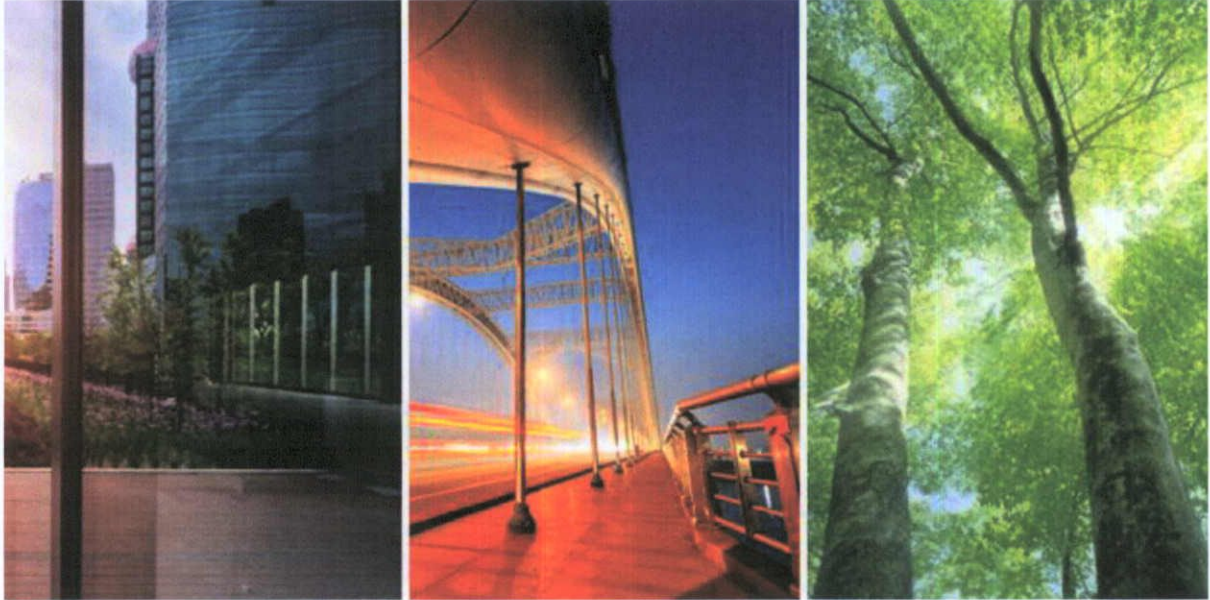

Dublin Central

Outline Construction & Demolition Management Plan – Site 2

Dublin Central GP Limited

DC-WAT-2X-XX-RP-C-001012

Sept. 2022

Waterman Moylan Consulting Engineers Limited

Block S, Eastpoint Business Park, Alfie Byrne Road, Dublin D03 H3F4.

www.waterman-moylan.ie

Client Name: Dublin Central GP Limited
Document Reference: DC-WAT-2X-XX-RP-C-001012
Project Number: 19-021

Quality Assurance – Approval Status

This document has been prepared and checked in accordance with Waterman Group's IMS (BS EN ISO 9001: 2015, BS EN ISO 14001: 2015 and BS OHSAS 18001:2007)

Issue	Date	Prepared by	Checked by	Approved by
P1	28.09.22	R. Nelson	C. Beresford	<i>Joseph Gibbons</i>

Comments

Disclaimer

This report has been prepared by Waterman Moylan, with all reasonable skill, care and diligence within the terms of the Contract with the Client, incorporation of our General Terms and Condition of Business and taking account of the resources devoted to us by agreement with the Client.

We disclaim any responsibility to the Client and others in respect of any matters outside the scope of the above.

This report is confidential to the Client and we accept no responsibility of whatsoever nature to third parties to whom this report, or any part thereof, is made known. Any such party relies on the report at its own risk.

CONTENT

Content	1
1. Introduction	4
2. Site Master Plan	6
2.1 MetroLink Enabling Works	7
2.2 Site 2 Location & Proposed Development	9
2.3 Sequencing of Works	10
2.4 Key Milestones	15
3. Construction Methodology – Metro Enabling Works	16
3.1 Description of the works	16
4. Construction Methodology – Over Site Development	18
4.1 Basement Sub-Structure & Foundations	18
4.2 Transfer Structure Over MEW shell	19
4.2.1 Secant Pile Retaining Wall	21
4.3 Block 2AB: Super-Structure & Building Frame	22
4.4 Block 2C: Super-Structure & Building Frame	24
4.5 Retained Facades	26
4.6 59-60 O’Connell Street Upper “The Reading Room”	27
4.6.1 Structural Assessment	27
4.6.2 Boundary Conditions	28
5. Site 2: Site Setup	29
5.1 Site 2 Hoarding	29
5.2 Site 2 Compound	30
5.3 Access & Egress	30
5.4 Logistics	31
5.5 Proposed Craneage Strategy	31
5.6 Power, Waste & Drainage	32
5.7 Working Hours	32
5.8 Car Parking	32
5.9 Wheel Washing Facility Requirement	32
5.10 Expected Vehicle Movement	33
5.11 Security	33
5.12 Diaphragm Wall Site Setup	34
6. Protection of Retained Structures during Construction	36
6.1 Existing Buildings	36
6.2 14-17 Moore Street - National Monument	38

6.3	Site 2 – Retained Facades.....	39
6.3.1	Structural Assessment	39
6.3.2	Temporary Condition.....	40
6.3.3	Temporary Condition – 43-45 O’Connell Street Upper	40
6.3.4	Retained Facades – 52-54 O’Connell Street Upper	42
6.3.5	Retained Facades – 57-58 O’Connell Street Upper	43
6.4	Adjoining Buildings.....	44
6.4.1	Structural Assessment	44
6.4.2	Temporary Condition.....	44
6.5	Site 2: Basement Impact Assessment	46
6.6	Movement Monitoring of Retained and Existing Structures.....	46
6.6.1	Overview	46
6.6.2	Proposed Monitoring Regime	46
7.	Control and Monitoring of Noise, Vibration and Dust on site.....	48
7.1	Condition Surveys	48
7.2	Noise Monitoring	48
7.2.1	Measures to Mitigate Noise	49
7.3	Vibration	49
7.3.1	Proposed works and potential risks	49
7.3.2	Vibrations Standards.....	50
7.3.3	Impact of ground borne vibrations arising from Proposed works	50
7.3.4	Mitigation Measures to be put in place prior to works.....	51
7.3.5	Monitoring and Mitigation for Ground borne Vibrations during Construction Works	52
7.3.6	Limits for Ground Borne Vibrations.....	53
7.4	Air & Dust Management.....	54
8.	Construction and Demolition Waste Management	56
8.1	Non-Hazardous Construction Waste	56
8.2	Potential Hazardous Wastes Arising.....	57
8.2.1	Contaminated Soil.....	57
8.2.2	Fuel/Oils	58
8.2.3	Invasive Plant Species	58
8.2.4	Asbestos	58
8.2.5	Other known Hazardous Substances	58
8.3	Main Construction and Demolition Waste Categories	59
8.4	Demolition Waste Generation	60
8.5	Appointment of C&D Waste Manager.....	61

9. Archaeology62

10. Building Control Amendment Regulations63

 10.1 Quality Assurance during Construction and BC(A)R Compliance63

11. Liaison with Third Parties64

Appendix A – Site 2 Site Setup

Appendix B – Construction Sequencing

Appendix C – Temporary Work

1. Introduction

Waterman Moylan have prepared the following Outline Construction and Demolition Management Plan for the implementation of the construction stages of the proposed Dublin Central development. It is noted that the development will be constructed in phases which are outlined in this report. This plan is prepared for Site 2 relating to the relevant Planning Application.

Dublin Central GP Limited is aware of the challenges that exist in delivering such a large and complex development within the city centre.

The plan sets out typical arrangements and measures which may be undertaken during the demolition and construction stages of the project in order to mitigate and minimise disruption and disturbance to the area around the site. Of particular note, are the protected and retained buildings and facades within and around the site, including the nearby National Monument located at Nos 14-17 Moore Street.

This plan will be used to guide the Main Contractor/Contractors who will have ultimate responsibility for developing a more detailed demolition and construction management plan for formal agreement with Dublin City Council in advance of them commencing the demolition or construction works on site. This plan will provide Dublin City Council with an outline proposal of how construction will be managed to comply with Local Authority and statutory requirements and will be updated post award of planning to reflect specific planning conditions which may be applied to the development.

This plan should be read in conjunction with all other planning stage reports included as part of this planning application.

The Dublin Central project is an expansive (c.2.2 Ha) and complex regeneration project. It needs to be delivered in stages to overcome site and project constraints.

A site wide cumulative masterplan encompassing an area of c2.2 Ha has been prepared by 'the Applicant' to set out the overall development vision for the Dublin Central project. The Masterplan area encompasses almost entirely three urban blocks and includes structures of heritage significance that will be retained. The area will include the MetroLink Station, which will be part of a separate application for approval to be made by Transport Infrastructure Ireland (TII).

Located in the east of 'the Masterplan' area. Site 2 is bounded generally by O'Connell Street Upper to the east, Nos. 59 & 60 O'Connell Street and Henry Place to the south, Moore Lane to the west, and Site 1 to the north and the rear of No. 59 & 60 O'Connell Street.

Site 2 contains the following protected structures: Nos. 43-44, 52-54, 57-58 (only upper facades protected) and the rear of 59 O'Connell Street Upper, and lies within the O'Connell Street ACA.

The existing buildings and facades noted above are to be incorporated into the proposed scheme. Additionally, the Reading Room to the rear of 59 O'Connell Street Upper is also to be retained and incorporated. Structural design strategies, construction methodology and sequencing, and temporary works strategies have been reviewed and proposed in order to protect retained structures on and adjacent to the site.

'The Masterplan' (March 2021) proposes 2 independent buildings above ground on the Site 2 development. Block 2AB provides ground floor retail and café / restaurant uses and offices above and ranges in height from 2 to 7 storeys over new single storey combined basement which also extends beneath with Block 2C. A new street is also provided between the 2 buildings connecting O'Connell Street Upper and Moore Lane. Block 2C provides the same ground floor retail and café / restaurant

uses with offices above ranging in height from 5 to 8 storeys over the combined basement beneath Block 2AB.

Both Sites share a single storey basement to include a car park and plant. The shared basement car park and plant rooms are to be constructed from reinforced concrete walls and slabs. The proposed structural solution for Block 2AB superstructure is an in-situ reinforced concrete slab construction with in-situ reinforced concrete columns and core walls. The structural solution for Block 2C is a pre-cast concrete structural frame.

As part of the Dublin Central development there is a requirement to incorporate MetroLink Enabling Works (MEW) within the design and construction of Site 2. Through consultation with Transport Infrastructure Ireland (TII), and based upon the current TII preliminary design carried out by Jacobs Idom a structural "box" beneath the ground floor level has been incorporated in the Site 2 basement design. The structural box is to accommodate the independent construction and operation of the planned O'Connell Street MetroLink Station which is being designed by Transport Infrastructure Ireland. This includes provision of co-ordinated voids to accommodate station entrances, ventilation, and fire escape shafts through this part of the Dublin Central proposed development. These ensure that the proposed Dublin Central development is structurally independent of, and not prejudicial to, the MetroLink project. The MetroLink project will be the subject of a separate application for approval to be made by Transport Infrastructure Ireland in Q3 2022. MetroLink Enabling Works (MEW) are however proposed within the Site 2 application, to be undertaken by the Applicant, with the actual station and railway works to be undertaken separately by TII at a later date.

2. Site Master Plan

The Dublin Central project is an expansive (c.2.2 Ha) and complex regeneration project. It needs to be delivered in stages to overcome site and project constraints.

A site wide cumulative masterplan has been prepared by the Applicant to set out the overall development vision for the Dublin Central project. 'The Masterplan' area encompasses almost entirely three urban blocks. The area is bounded generally by O'Connell Street Upper and Henry Place to the east, Henry Street to the south, Moore Street to the west, and O'Rahilly Parade and Parnell Street to the north. Moore Lane extends south from Parnell Street through the centre of the masterplan area, as far as its junction with Henry Place.

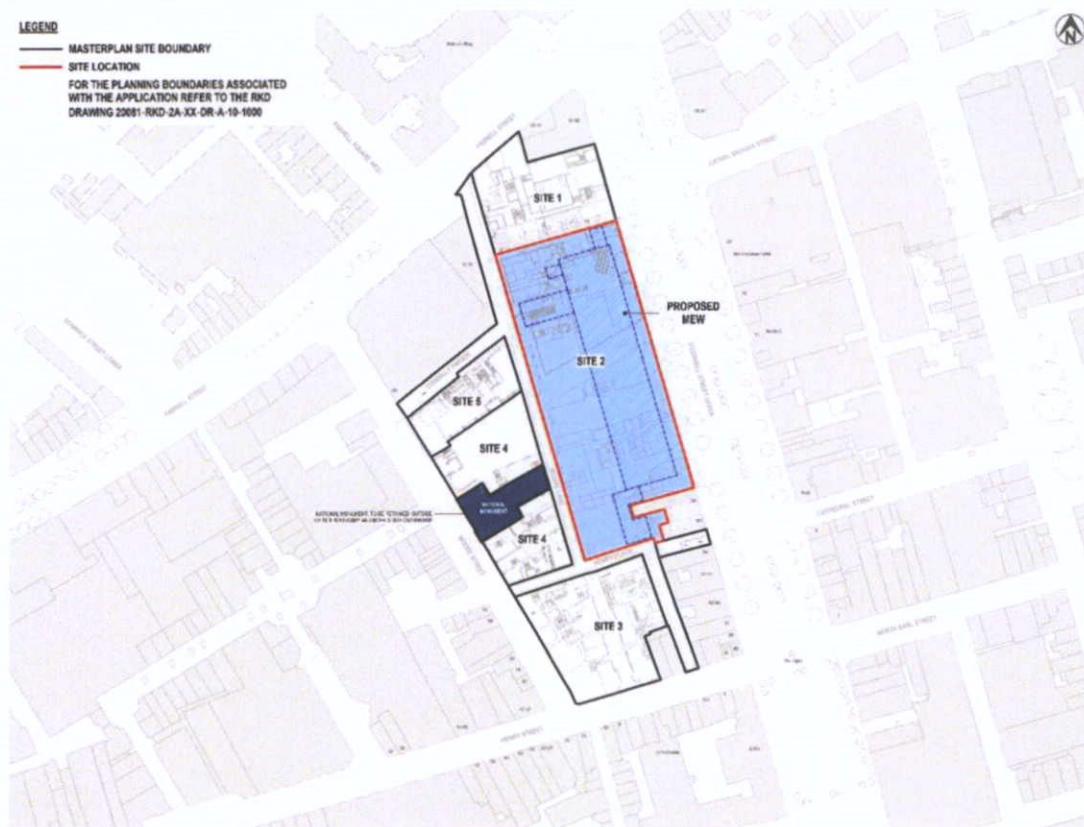

Figure 1. Site 2 Location Plan

'The Masterplan' area includes structures of heritage significance that will be retained. Nos.14 -17 Moore Street are under the ownership of the Dept. of Housing, Local Government and Heritage and are not part of the Masterplan area. The buildings have been designated National Monument status and are subject to a preservation order.

The Masterplan area has been divided into five identifiable sites for the purpose of making planning applications. The adopted site numbering is shown in Figure 1 and Figure 2, also showing the location of each site within the Masterplan. For the planning boundaries associated with the application refer to the RKD drawing 20081-RKD-2A-XX-DR-A-10-1000. Site 2 is also subdivided into Block 2AB and Block 2C to enable reference to the 2 buildings that sit above a combined basement and the proposed MetroLink Enabling works.

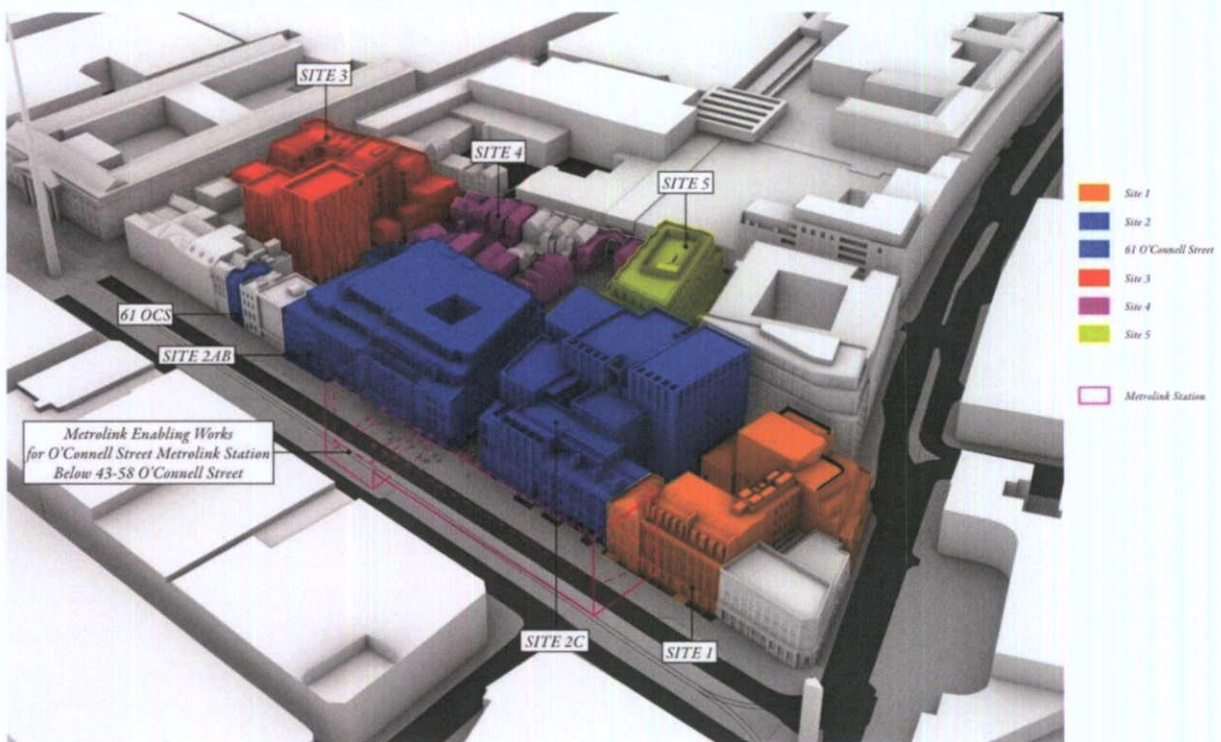

Figure 2. Masterplan

2.1 MetroLink Enabling Works

The National Transport Authority (NTA) and Transport Infrastructure Ireland (TII) approached the Applicant in 2018 with a view to locating a future MetroLink Station serving O'Connell Street within the Dublin Central site, in an effort to avoid locating the Station within the central median of O'Connell Street. TII is in the process of finalizing the design of the MetroLink project. TII is expected to make an Application for a Railway Order for the MetroLink project, including the O'Connell Street Station, in Q3 2022.

As part of the Dublin Central development there is a requirement to incorporate MetroLink Enabling Works (MEW) within the design and construction of Site 2. Through consultation with Transport Infrastructure Ireland (TII), and based upon the current TII preliminary design carried out by Jacobs Idom a structural "box" beneath the ground floor level has been incorporated in the Site 2 basement design. The structural box is to accommodate the independent construction and operation of the planned O'Connell Street MetroLink Station which is being designed by Transport Infrastructure Ireland. This includes provision of co-ordinated voids to accommodate station entrances, ventilation, and fire escape shafts through this part of the Dublin Central proposed development. These ensure that the proposed Dublin Central development is structurally independent of, and not prejudicial to, the MetroLink project. The MetroLink project will be the subject of a separate application for approval to be made by Transport Infrastructure Ireland in Q3 2022. MetroLink Enabling Works (MEW) are however proposed within the Site 2 application, to be undertaken by the Applicant, with the actual station and railway works to be undertaken separately by TII at a later date.

The provision of the MetroLink O'Connell Street Station and its associated tunnel works would be completed by the NTA/TII once ready to do so and subject to the required consents being in place. It is envisaged that the MEW works would be completed in advance of the NTA/TII tunnel boring machines reaching the area.

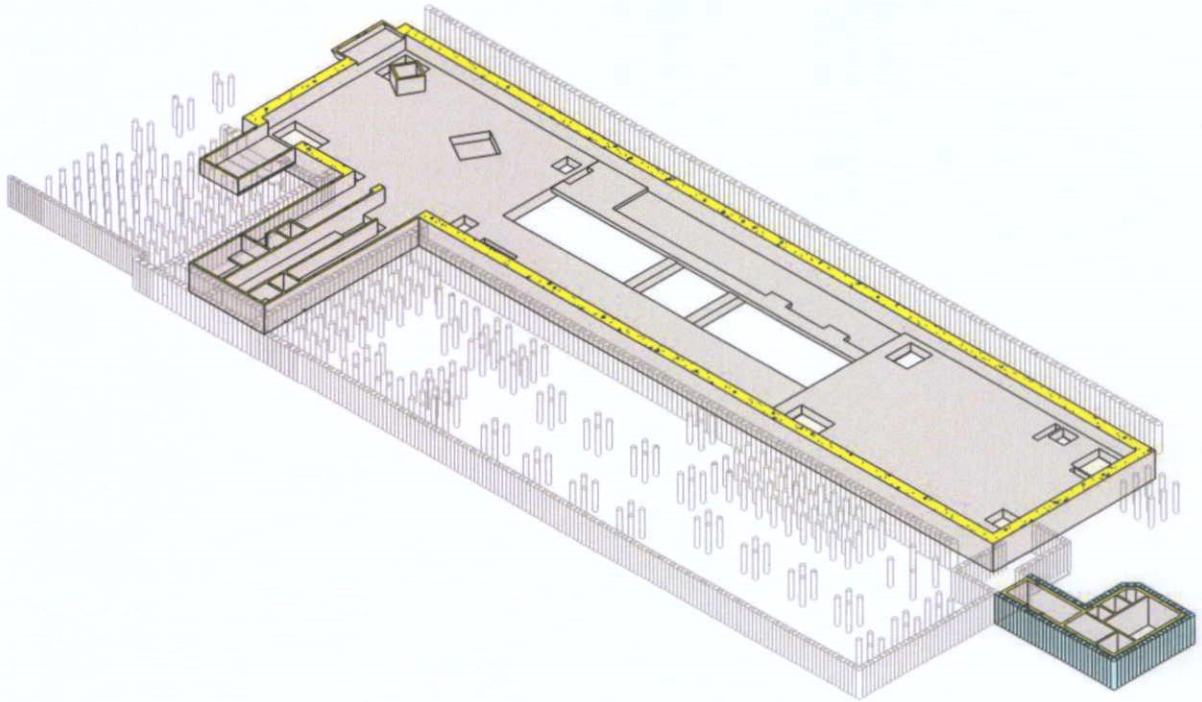

Figure 3. Section Through MEW Construction (Concourse Level)

2.2 Site 2 Location & Proposed Development

Located in the east of 'the Masterplan' area. Site 2 is bounded generally by O'Connell Street Upper to the east, the front portion of No. 59 & 60 O'Connell Street and Henry Place to the south, Moore Lane to the west and Site 1 to the north. It includes Nos. 43 – 59 O'Connell Street Upper (including the Carlton Cinema site), the rear of No. 59 & 60 O'Connell Street. The planned MetroLink, to be delivered independently by Transport Infrastructure Ireland (TII) will have a future station under Site 2.

Site 2 contains the following protected structures (only upper facades protected): Nos. 43-44, 52-54, 57 58, the rear of 59-60 O'Connell Street Upper, and lies within the O'Connell Street ACA.

'The Masterplan' (March 2021) envisages the follow development for this area:

Building 2AB – Mixed-use scheme accommodating ground floor retail and café / restaurant uses and office accommodation above and ranges in height from 2 to 7 storeys over a new single storey combined basement shared with Block 2C. The provision of a new street connecting O'Connell Street and Moore Lane between the new buildings.

Building 2C – Mixed-use scheme accommodating ground floor retail and café / restaurant uses with offices above 5 to 8 storeys over the basement shared with Block 2AB. Provision of a new street connecting O'Connell Street and Moore Lane.

The entire basement under buildings 2C and 2AB and associated site development works will also be co-ordinated with the MetroLink Enabling Works (MEW).

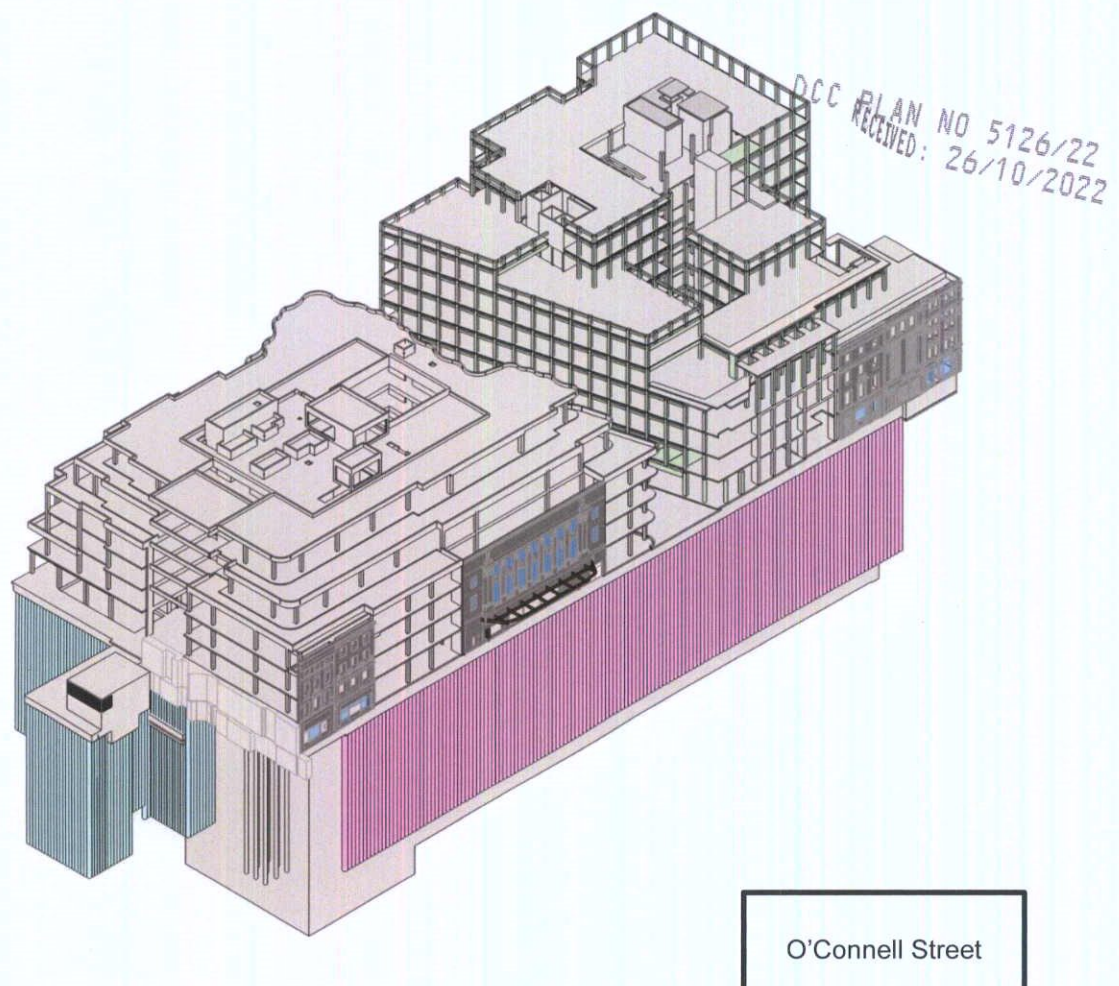

Figure 4. Proposed Site 2 Development

2.3 Sequencing of Works

Refer to the drawings included in Appendix B for details of each stage of the proposed construction phasing for the MEW and Site 2 substructure and superstructure works summarised below. The construction phasing plans will be updated as the design progresses and will be made available to the main contractors. The main contractor will be required to submit method statements and to secure all necessary consents and approvals for all activities critical to the safety of all surrounding property and public highway. The protected buildings and the other retained structures will be monitored as previously described and as noted in the Section 6. The use of written method statements and technical submissions and approvals will mitigate the risks as a result of the subterranean construction work.

In summary, the proposed construction phasing consists of:

1. Works completed prior to the Site 2 construction commencing
 - 3m wide exclusion zone erected around the National Monument with protective hoarding.
 - Creation of a new haul road along Moore Lane.
2. Demolition
 - Façade retention structures installed to all protected facades prior to commencing demolition.
 - Temporary works installed to all retained and neighbouring boundary properties prior to commencing demolition to protect structures during demolition and construction
 - Demolition of existing buildings to grade level within Site 2.

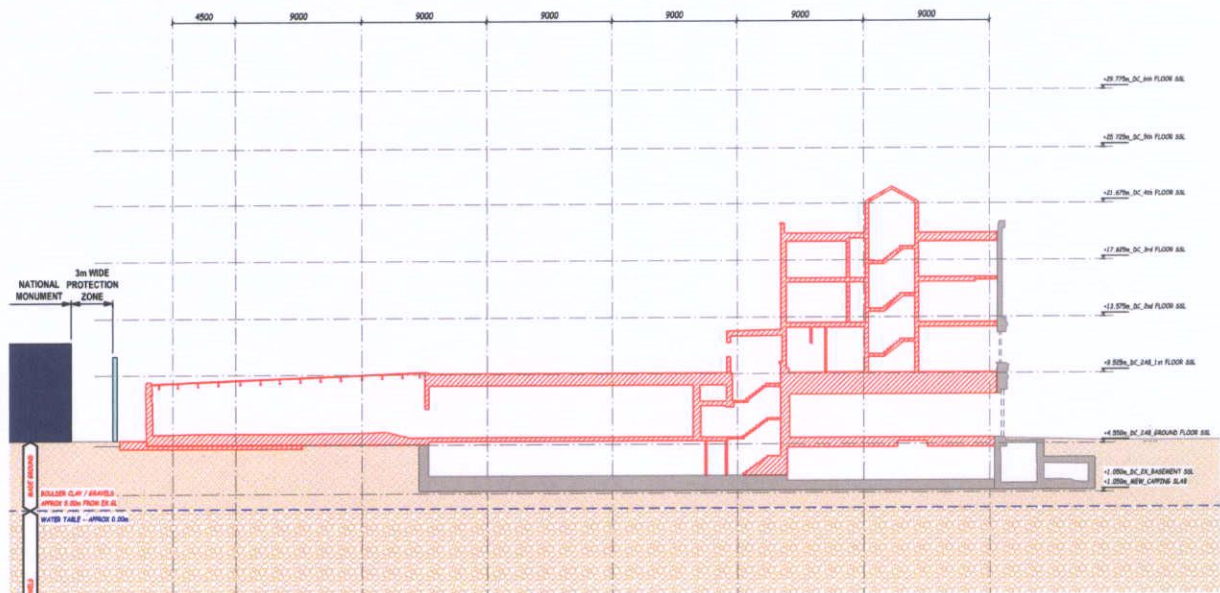

Figure 5. Site Set-up (1) and Demolition of Existing Buildings (2)

5. Bulk excavation for MEW

- Dewatering system provided as necessary to control ground water flows in the boulder clay and limestone.
- Excavation in layers of the ground within the D-Walls as part of the MEW.
- Install temporary works (propping) as required.

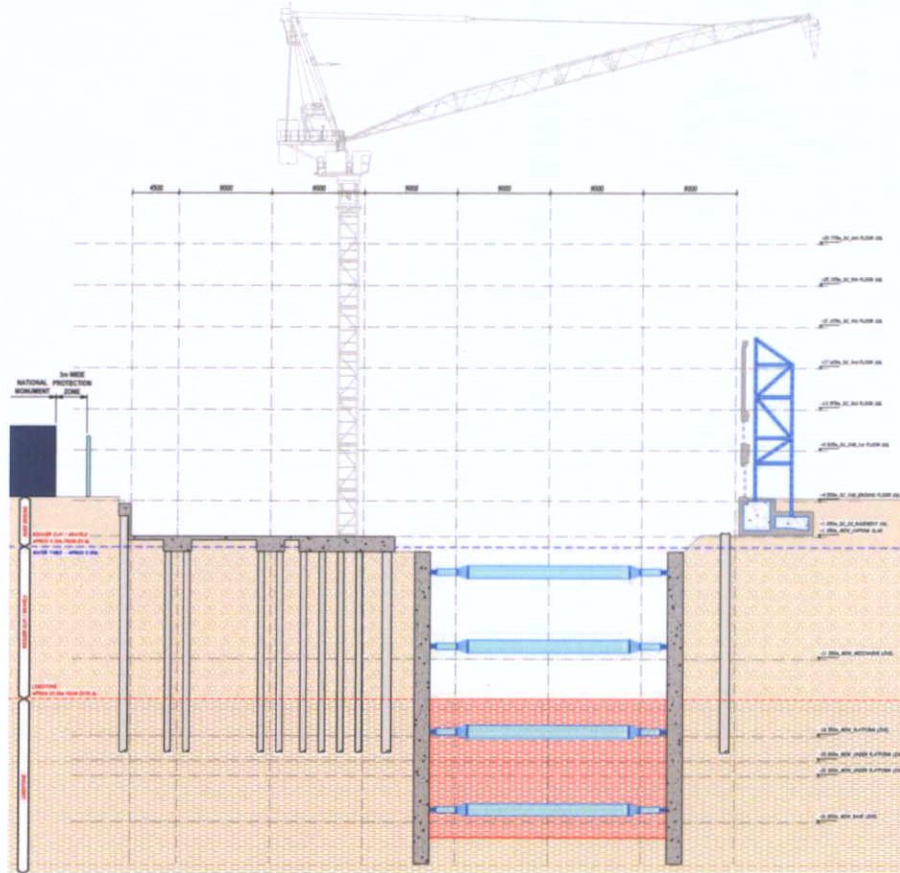

Figure 7. MEW Excavation (5)

7. Transfer beams and substructure to enable oversite development
 - Final excavation of Site 2 basement.
 - Site 2 basement slabs constructed, including transfer beams/rafts over station box.
8. Completion of substructure
 - Construction of the Site 2 basement slabs and retaining walls.

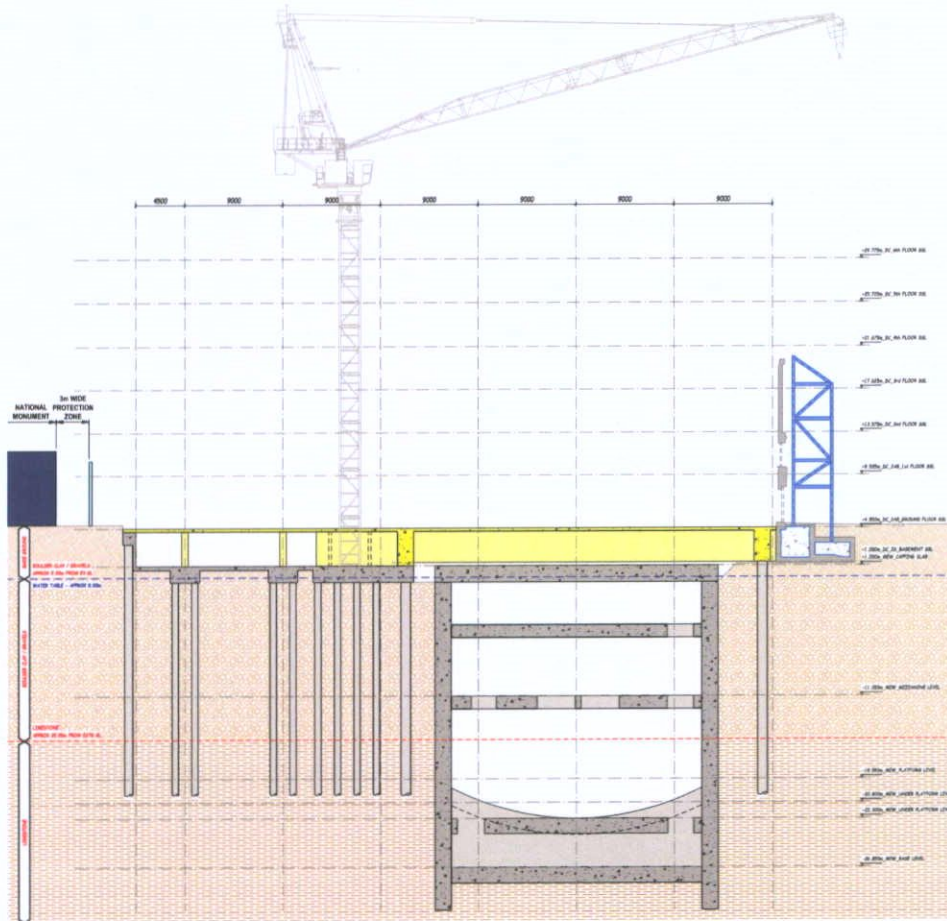

Figure 9. Transfer Over MEW (7) and Completion of Site 2 Basement (8)

9. Completion of superstructure

- Construction of the Site 2 superstructures
- Façade retention system to be removed on completion of superstructure and permanent restraint of facades to primary structure
- Temporary haul road and protection to the National Monument to be removed upon completion of the works.

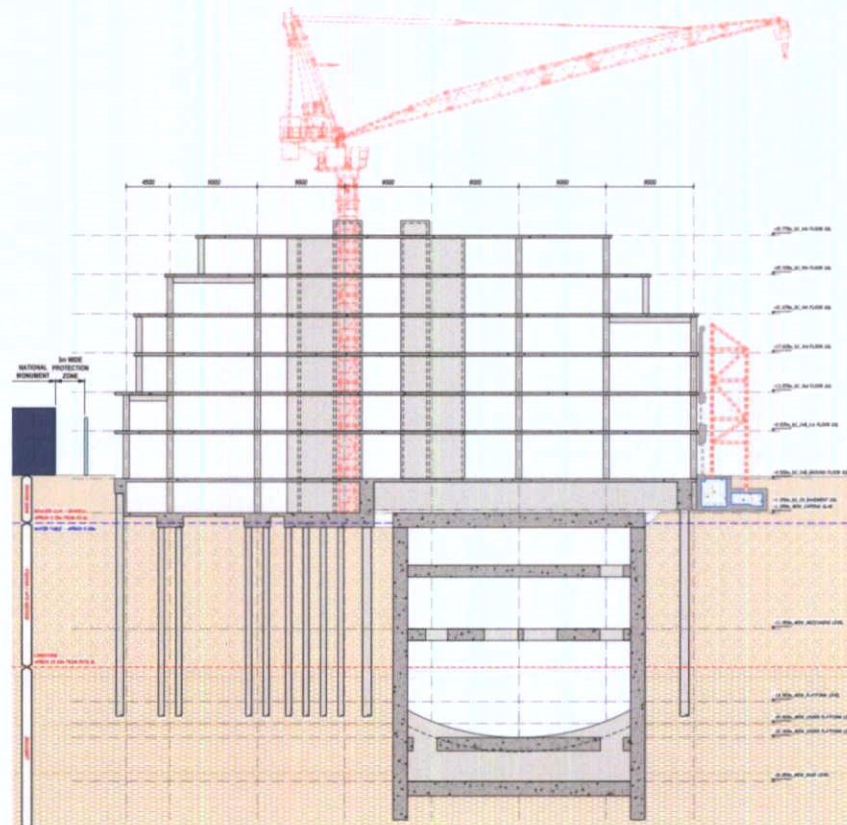

Figure 10. Completion of Site 2 Superstructures (9)

2.4 Key Milestones

Key Milestone Date	Site 2 Works
Q1 2024 – Q3 2025	Site Preparation
Q1 2024 – Q2 2026	Metro Enabling Works Construction
Q3 2026 – Q4 2027	Basement Construction
Q1 2028 – Q3 2030	Construction
Q2 2030 – Q1 2031	Fit-Out Works
Q2 2031	Completion

3. Construction Methodology – Metro Enabling Works

3.1 Description of the works

The final construction sequence will be based on the contractors preferred method however the typical construction sequence involves the construction of a shallow guide wall to maintain the setting out and verticality of the main wall. Panels of the diaphragm wall are then excavated using cutting or grabbing machinery. Based on the depth to the Calp Limestone formation, and the proposed levels of the station box, it is assumed a proportion of the excavation will be within the rock and therefore a hydraulic cutting machine is likely to be used.

In order to support the sides of the excavation prior to concreting, Bentonite is pumped into the excavation which exerts a hydraulic pressure against the trench walls and prevents collapse of the side. The bentonite fluid will be mixed and stored on site and re-used across multiple excavations..

Reinforcement is prefabricated on site and is then positioned in the bentonite filled trench. The connection points for the curved base slab, and the slabs at the mezzanine, concourse, and capping slab levels can be blocked out within the reinforcement cage to allow for connection at the relevant point of the construction sequence. Concrete is then poured into the trench, typically through tremie pipes that extend to the bottom of the trench and fill from the bottom up. The support fluid is displaced as the concrete is pumped into the trench and can be re-use in other excavations for the wall.

The MEW construction has been considered as a bottom-up construction where the excavation will be advanced down to the lowest level with the structure then being constructed from this bottom level. In the permanent condition the reinforced concrete slabs will act as permanent props between the diaphragm walls to resist lateral pressures. In the temporary condition horizontal props will be installed successively as excavation progresses downwards.

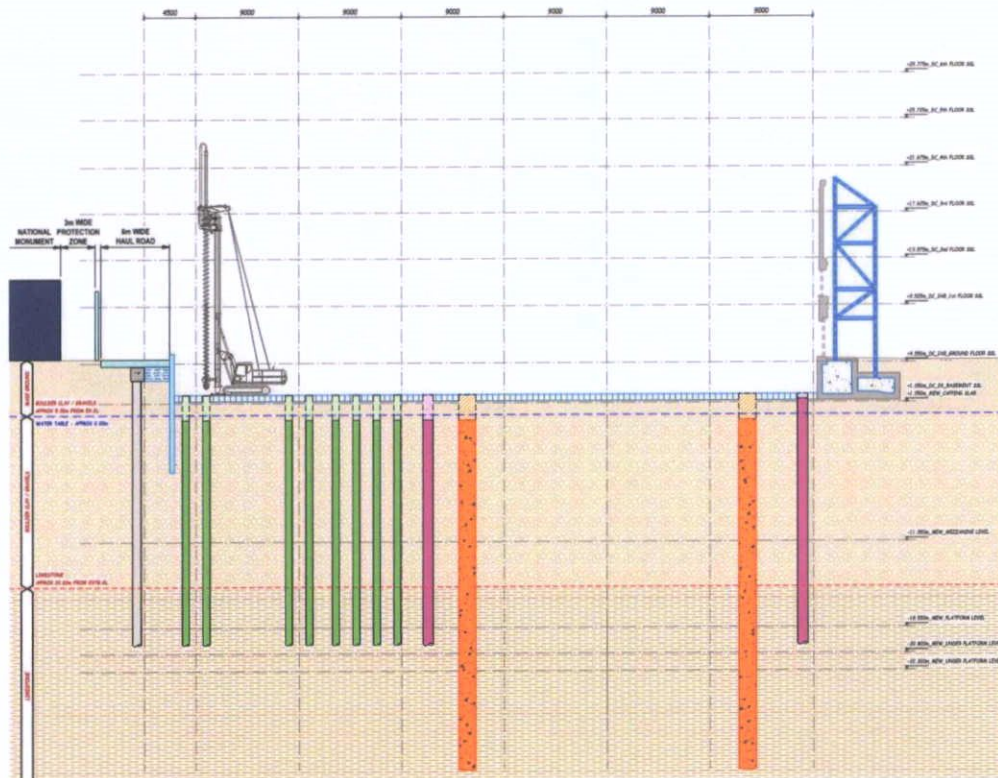

Figure 11. Construction Phasing Showing Construction of D-Walls

Once bottomed out the new lowest level slab will be cast, and work will proceed upwards with the temporary props being removed once the concrete slabs have reached the desired strength at each level. This will continue until the basement MEW works are complete.

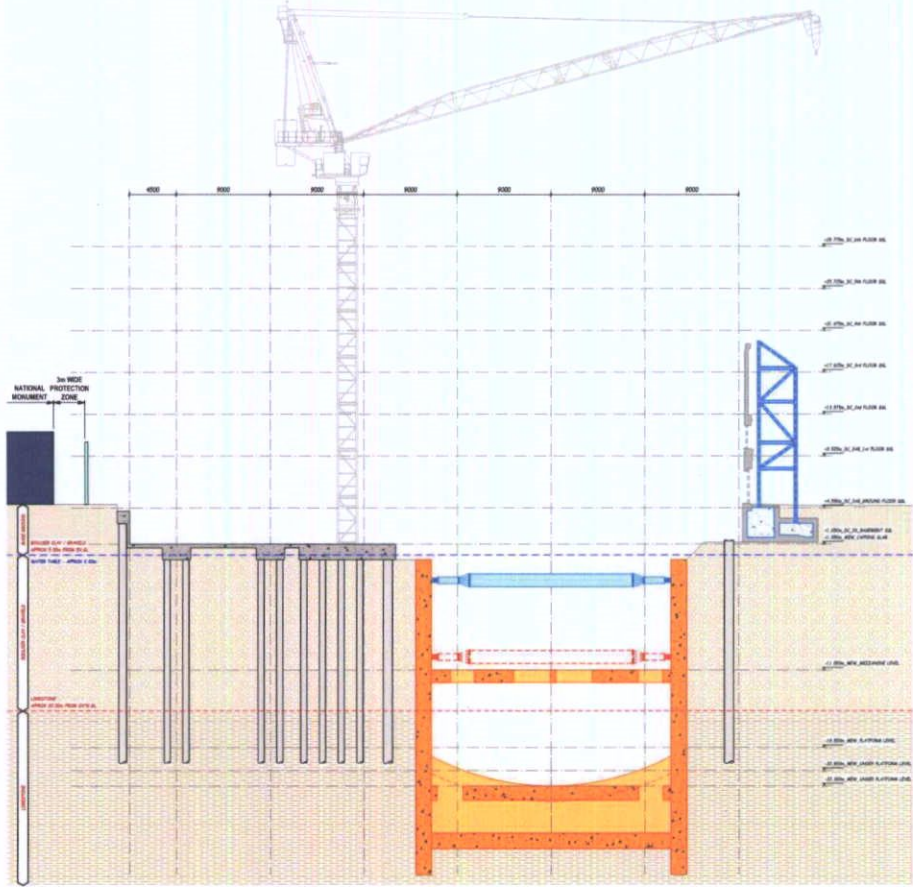

Figure 12. Construction Phasing Showing Temporary Propping and Slab Construction

4. Construction Methodology – Over Site Development

4.1 Basement Sub-Structure & Foundations

Sites 2 comprises a single storey basement that encompasses Block 2AB and Block 2C. The basement typically houses plant and ancillary services for the buildings above. There is also a car park located within the basement which is accessed from Moore Lane within the Block 2C boundary.

The basement enclosure comprises a contiguous pile wall at the boundary to the MEW on the east, a secant pile wall along Moore Lane to the west, and retaining walls constructed from the basement slab to the north and south. The retaining walls will return down the east and west sides of the basement to form a lining wall inside the pile wall. The basement wall will provide a grade 2 environment and form part of the waterproofing protection to the basement. The basement slab is formed by a 350mm thick reinforcement concrete base slab that spans between pile caps and the pile.

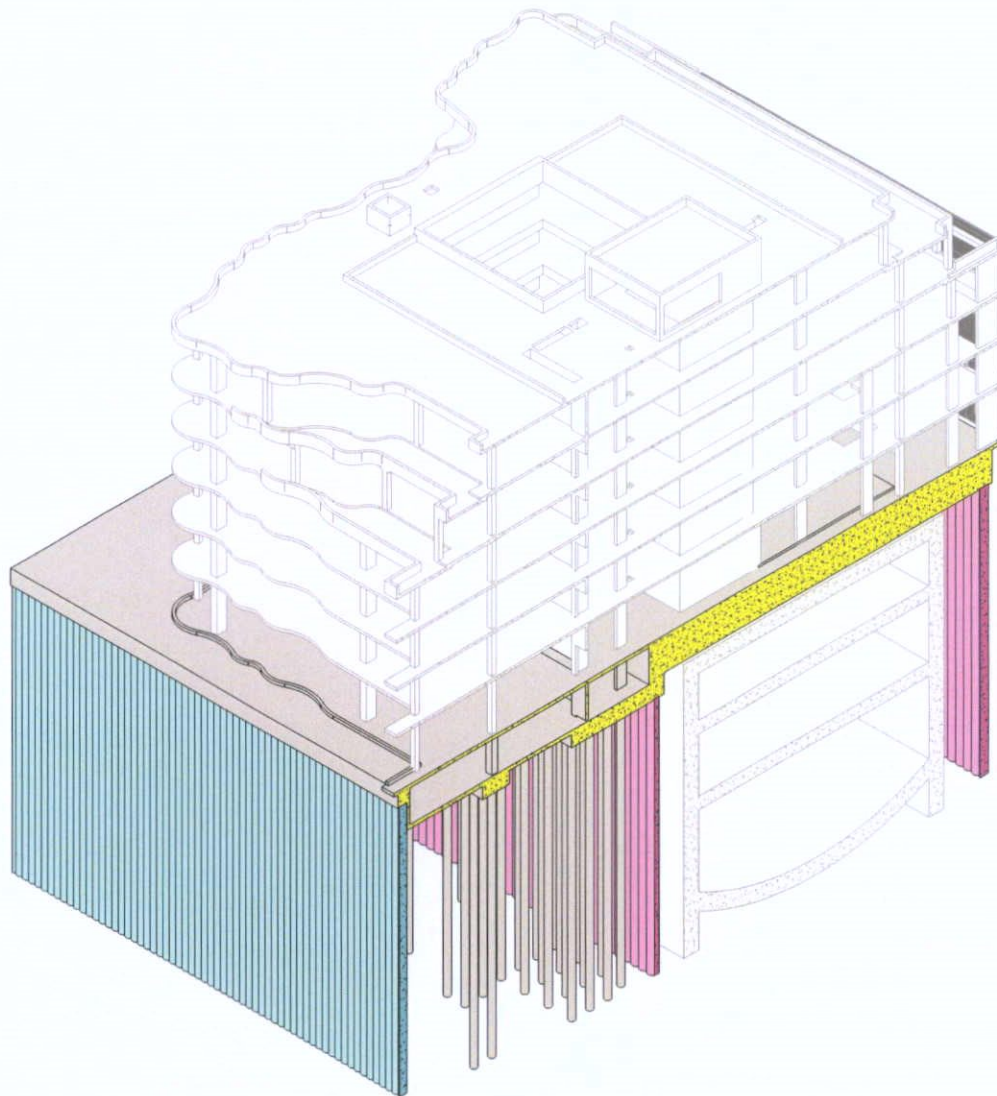

Figure 13. Proposed Site 2 Substructure Short Section (Through Block 2AB)

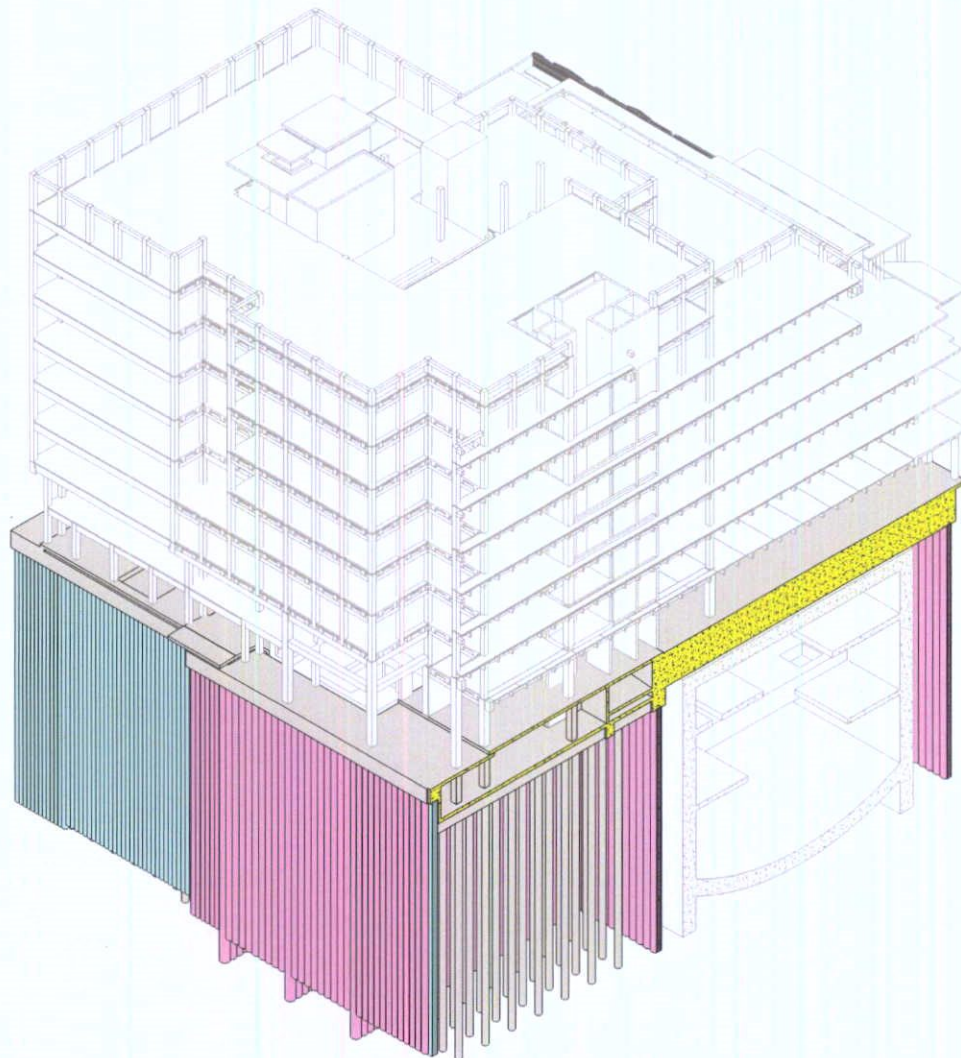

Figure 14. Proposed Site 2 Substructure Short Section (Through Block 2C)

The piled walls provide a temporary works solution to retain the made ground and enable an unpropped excavation of the basement along these elevations. The north and south boundaries of the basement to the existing buildings will be underpinned to avoid the excavation for the basement undermining the existing foundations. Temporary propping may be required during the excavation to protect the existing structures. The excavated material to form the over-site development basement will generally be made ground down to circa 5m below ground level then Alluvium (Sandy Gravel).

4.2 Transfer Structure Over MEW shell

To the east and west of the MEW a piled wall is to be installed to support the transfer structures bridging over the station box, which in turn support the proposed Block 2AB and Block 2C superstructures above.

On the western side of the MEW, it is also used to form the basement. Continuous capping beams sit on top of the piled walls and support the transfer structures over the MEW.

To span the 30m over the MEW, 3.5m deep transfer structures span between the capping beams. Over the majority of the station box, transfer beams have been located beneath the positions of the columns for the superstructure over. Where additional columns do not align with the primary transfer beams below, secondary beams span between primary transfer beams.

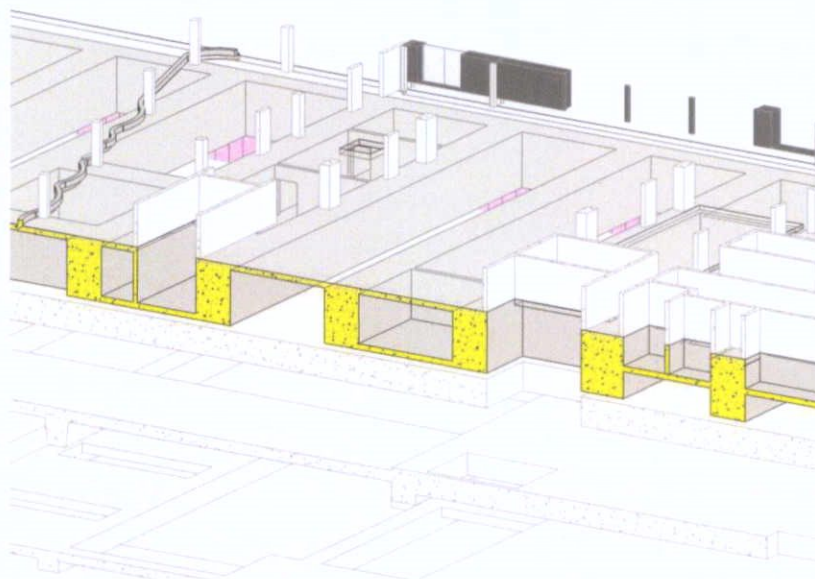

Figure 15. MEW Transfer Beam Detail

Beneath Block 2C there are significant openings at ground floor require by the MEW package works which do not allow transfer beams to span between the pile walls and support the columns over. Therefore, a 3450mm deep transfer slab spanning between the piled walls has been designed in this area to transfer the loads from the cores and columns of the superstructure above.

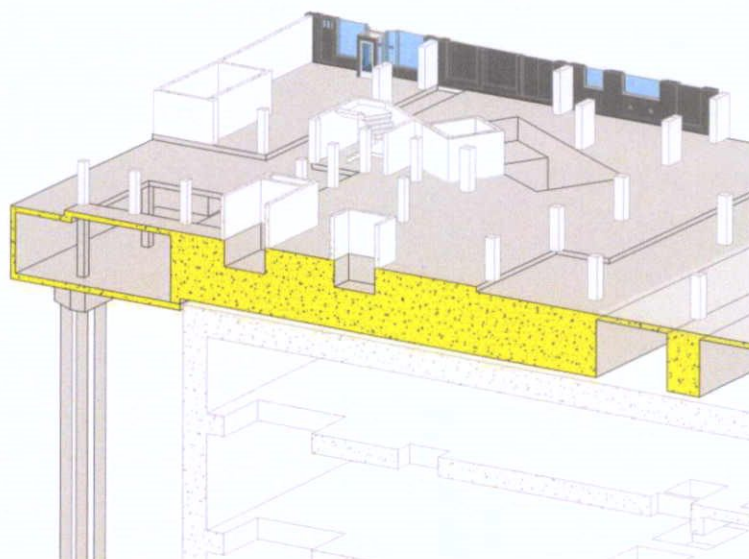

Figure 16. MEW Transfer Slab Detail

To maintain the structural independence required between the development structure and the MEW structure, a clearance between the underside of the transfer structures and the topping/roof slab for the

MEW has been provided. This is to allow for the deflection and construction tolerance of the transfer structures above without transferring load to the station structure. A lightweight, non-combustible, compressible void former will be placed above the capping slab and can be used as a permanent void former for the construction of the transfer beams and internal slabs. The specification of the void former with voids/cells will allow for the passage of water over the capping slab, as part of the waterproofing strategy.

4.2.1 Secant Pile Retaining Wall

The secant wall comprises interlocking hard (male) and firm (female) piles, which will provide an inherently stiff wall which will enable a robust temporary works solution to be adopted. The secant wall will also provide resistance to water penetration and loss of any fine material from behind the wall which could affect adjacent buildings and infrastructure. The secant wall will also provide direct support for the superstructure, with the capping beam approximately 1m wide by 1m deep distributing vertical loads along the length of the piled wall. The basement floor will act as a permanent prop providing restraint to limit ground movement of the wall due to lateral pressures.

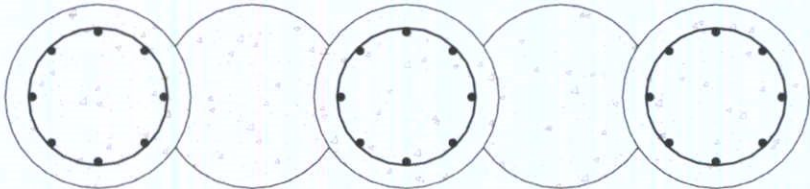

Figure 17. Male/ Female Interlocking Secant Pile Wall

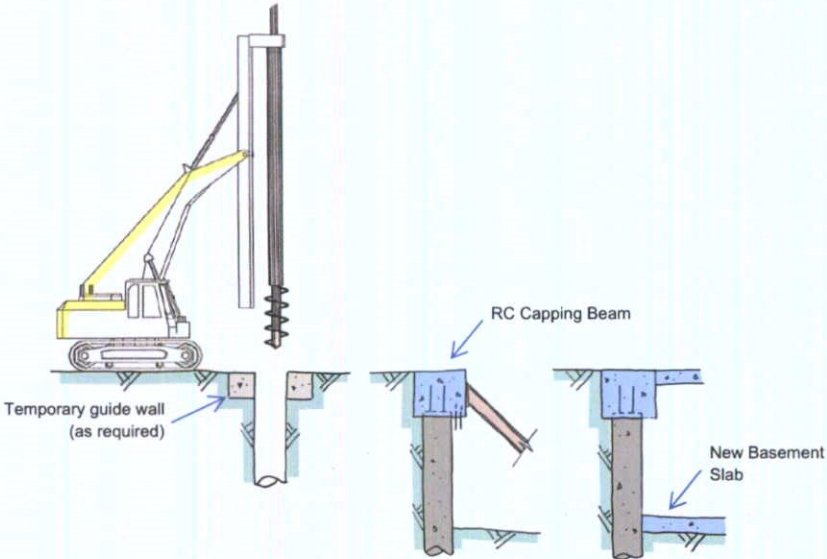

Figure 18. Typical Secant Pile Wall Construction

4.3 Block 2AB: Super-Structure & Building Frame

The proposed structural solution for Block 2AB is a reinforced concrete frame with flat slabs.

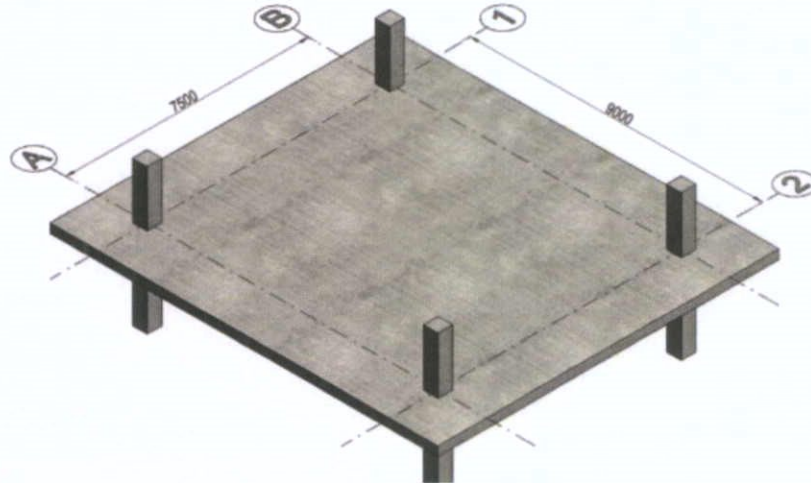

Figure 19. Block 2AB Typical Structural General Arrangement

The super-structure will likely use traditional construction techniques. The sequence of pouring the concrete stair and lift core and columns followed by the floor slab will continue on a sequential floor by floor basis.

The suspended slabs at each floor level above will likely use a proprietary formwork system (Peri Skydeck or similar). The decking will be erected complete with edge handrails and access towers to each level. Steel reinforcement will then be installed on the deck. Lifting of decking and rebar will be done using the tower cranes while static concrete pumps will be used to pour the concrete.

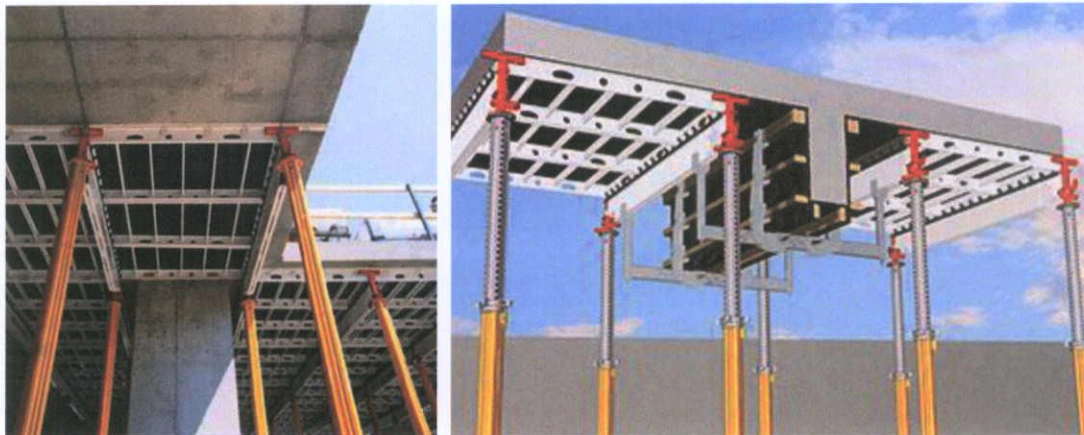

Figure 20 - Typical RC Formwork (Skydeck)

After curing of the slab, the formworks will be removed for reuse on the next floor above while the supports remain in place as back propping. Back props will be removed at a later date once the building has progressed and the concrete has cured sufficiently to remove the props.

Concrete placement will typically be via pumping for all large pours to free up the crane for other lifting operations. Wind and weather will be monitored and crane usage will be restricted as required during inclement weather to ensure safety of all personnel.



Figure 21 - Typical Concrete Placement

4.4 Block 2C: Super-Structure & Building Frame

The structural solution for Block 2C comprises a precast concrete structure. The floors comprise precast "Double Tee" units supported on "Tee" or "L" shaped beams depending on the location and span arrangement. The columns are also precast concrete and the core walls are 250mm thick in-situ reinforced concrete.

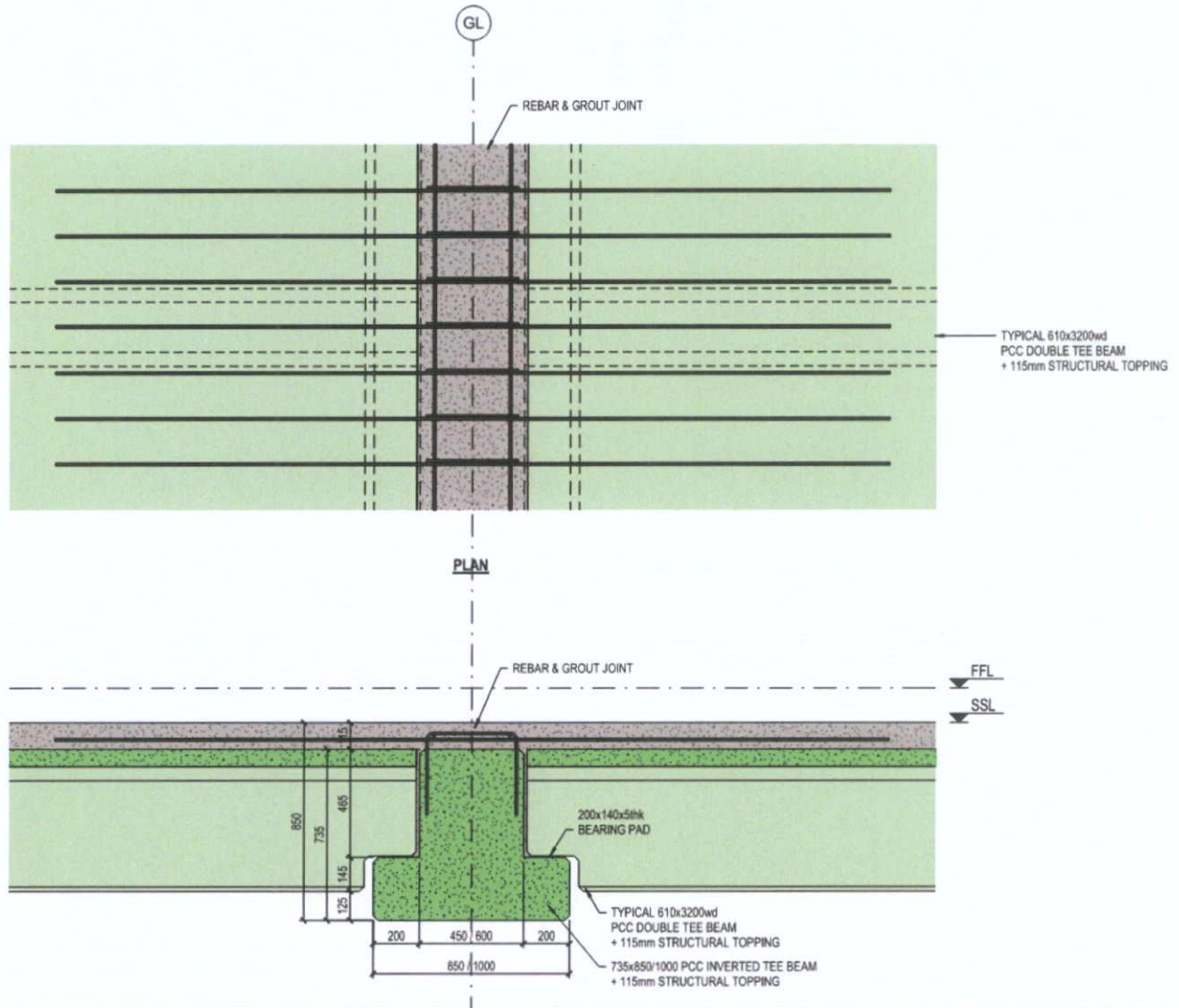

Figure 22. Typical Banagher Pre-cast Concrete Double Tee Beam Detail

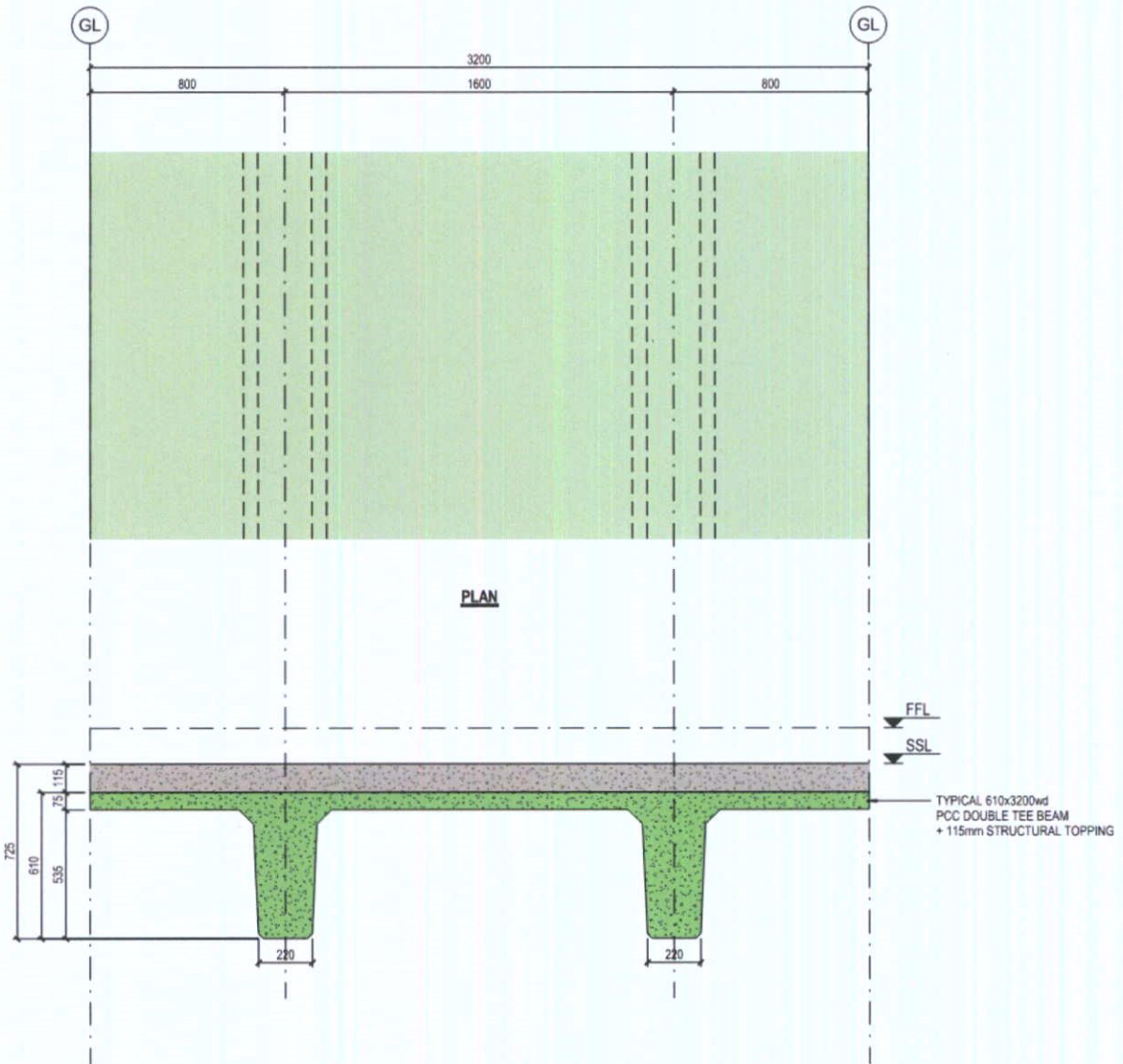

Figure 23 Typical Banagher Pre-cast Concrete Double Tee Beam Profile

The structural bay on the east elevation, behind the retained facades, will likely be constructed in an in-situ concrete strip to provide a transfer structure for columns over at the step backs in the building line at upper levels. The in-situ floor construction also allows for variations in the slab edge on this façade to accommodate the architectural detailing.

Similarly, around the central cores, the slab will likely be constructed locally in in-situ reinforced concrete to accommodate, lift and stair positions, walkways and lobbies, and architectural layouts. The slab spans between columns around the central void, core walls, and pre-cast beams.

The precast concrete elements will be manufactured off-site and delivered to site on a just-in-time basis. The floors and columns will be erected on a sequential floor-by-floor basis with the structural screed topping poured sequentially after. The precast elements will be installed using the tower cranes while static concrete pumps will be used to pour the reinforced concrete topping.



Figure 24. Typical Precast Concrete Construction

4.5 Retained Facades

The existing facades at Nos. 43-45, 52-54 (Carlton Façade), and 57-58 O'Connell Street Upper are to be retained and laterally restrained by the new building structure at every floor level.

The ground floor entrance to 52-54 (Carlton Façade) O'Connell Street Upper has been schemed to enable a large clear span entrance to the retail area. This requires further investigation to determine the nature of the existing structure that supports the façade at first floor level. The Site 2 Engineering Design Report, has resolved a solution to resupport the façade to provide a flexible shop front to suit the tenants ultimate requirements.

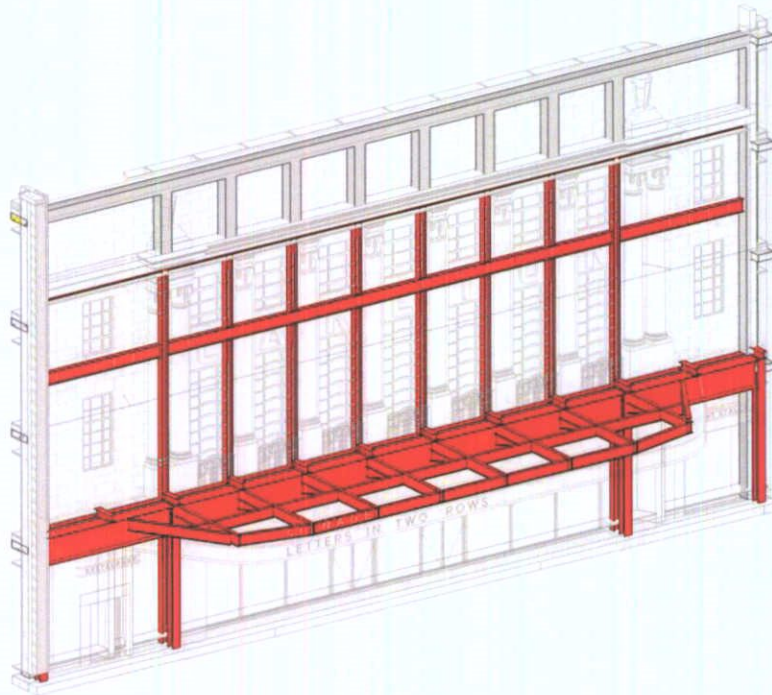

Figure 25. 52-54 (Carlton Façade) O’Connell Street Upper Steel Frame Support

4.6 59-60 O’Connell Street Upper “The Reading Room”

The Reading Room is an historical section of the building at the rear of 59-60 O’Connell Street Upper of heritage importance. It is not a protected structure but is to be retained within the proposed development.

4.6.1 Structural Assessment

Where the new layout permits, the design approach to the Reading Room at the rear of 59 O’Connell Street is for refurbishment and conservation rather than replacement, but considerations will also be given to the need for ongoing and potentially increasing maintenance given the age of the existing structure. Where repairs are required, they will be undertaken with consideration to the existing materials and construction.

Given the age and layout of the building it is likely to comprise of a mixture of loadbearing masonry, timber floor joists and floorboards, possibly including some beams either timber or later steel additions to reduce the spans of the floor joists.

The layout of the existing structure is to be confirmed following site investigations once the internal finishes have been removed. The inspection will confirm the existing structure including the construction of the partition walls and assumed construction and structural span of the floors. The structural assessment will include sampling and testing of the structural fabric to confirm strength and material properties.

There are a number of modifications proposed for the structure and external works around the building. The impact of the MEW works in this location is a further consideration and the structural concepts proposed have taken this into consideration.

4.6.2 Boundary Conditions

There will be a deep excavation to enable the formation of a shaft to provide an access route into the future station (by others). The proposed structure in the area around the Reading Room comprises of Secant piled walls which will be bored a suitable depth below the full depth of the access shaft. The excavation to form the shaft will then follow in stages and the secant piled walls will be propped across the width of the shaft to limit lateral soil movement. the secant piles will also limit the ground water seepage and therefore also reduce soil displacement and settlement of the Reading Room. The final design of the secant piled walls and the temporary works to back prop these will be the responsibility of the Piling specialist sub-contractor.

The detailing of the interface between the existing basement wall and the new piled walls will be carefully considered with the project architects and they will need to consider whether to provide ventilation and/or breather membranes and insulation to create similar or improved conditions to the current situation.

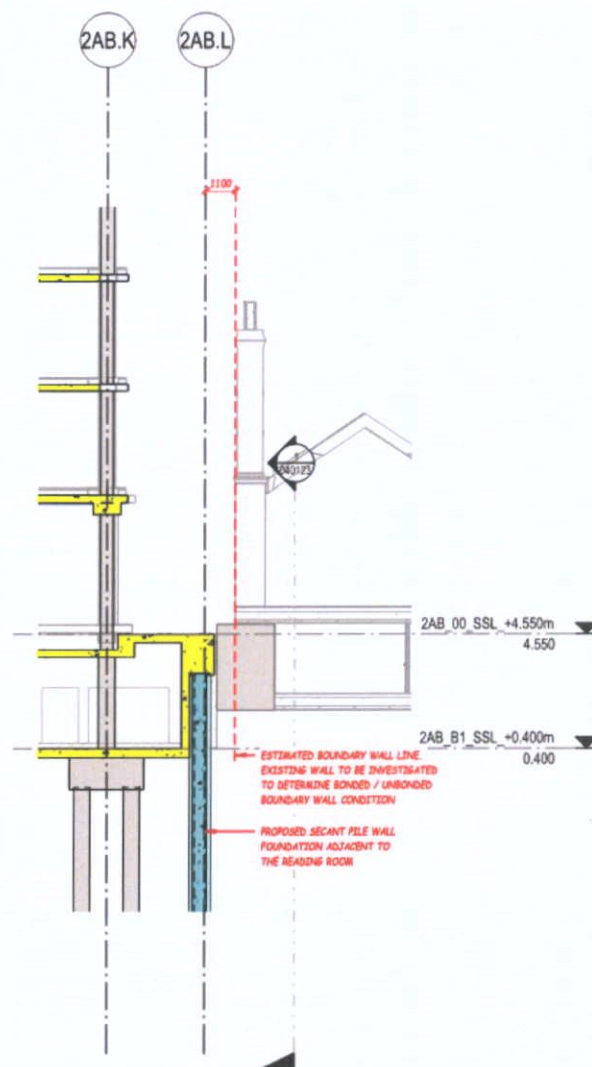

Figure 26. Secant Wall Adjacent to Existing Reading Room Basement

5. Site 2: Site Setup

Hoarding will be required to the Site 2 boundary. This will be located along O'Connell Street Upper, Moore Lane and Henry Place.

Vehicle gates with barriers will likely be accommodated at a security huts combined with a secure turnstile to control pedestrian and vehicle access. Vehicle access and egress routes will be located along Moore Lane.

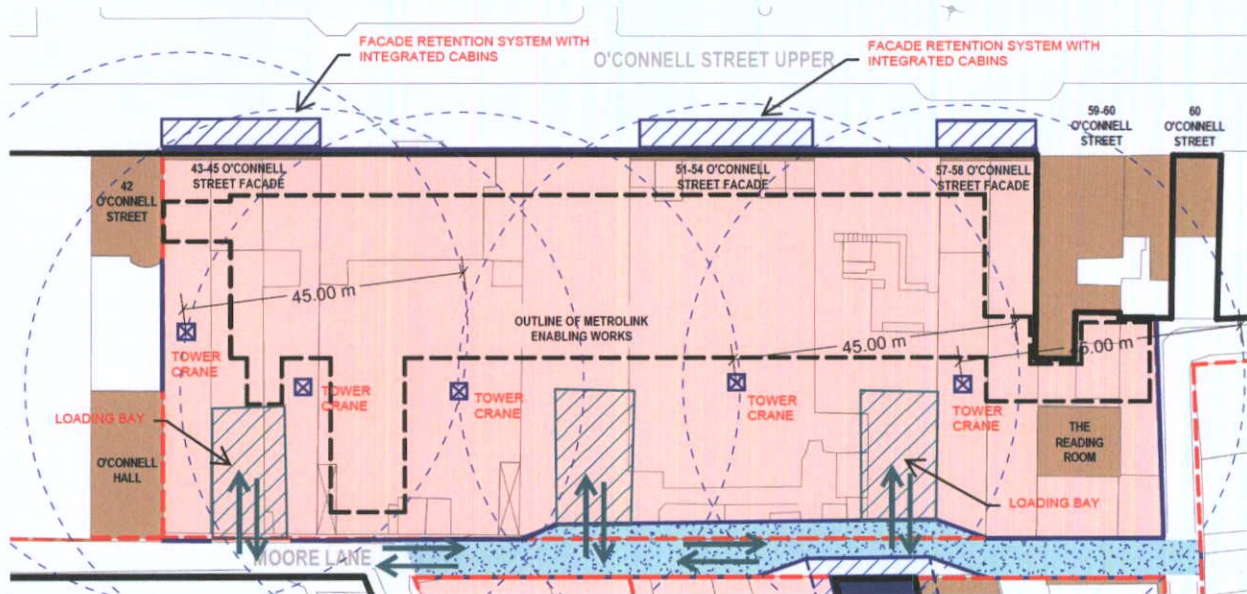

Figure 27. Site 2 Proposed Site Setup

5.1 Site 2 Hoarding

The hoarding will be designed at a later date by the Main Contractor/Contractors and will be designed to minimise impact to the footpaths along O'Connell Street Upper. Where necessary, the hoarding may be designed to incorporate covered walkways and elements of temporary works as part of the façade retention systems, to the agreement and approval of Dublin City Council.

The hoarding line will be maintained at all times during demolition and construction. In the event of any of the hoarding having to move outwards to facilitate construction activities, this will be done with the agreement of Dublin City Council including obtaining new hoarding licenses as required. If this encroaches on minimum footpath widths, the Main Contractor/Contractors will erect diversions to opposite footpaths to the agreement of Dublin City Council.

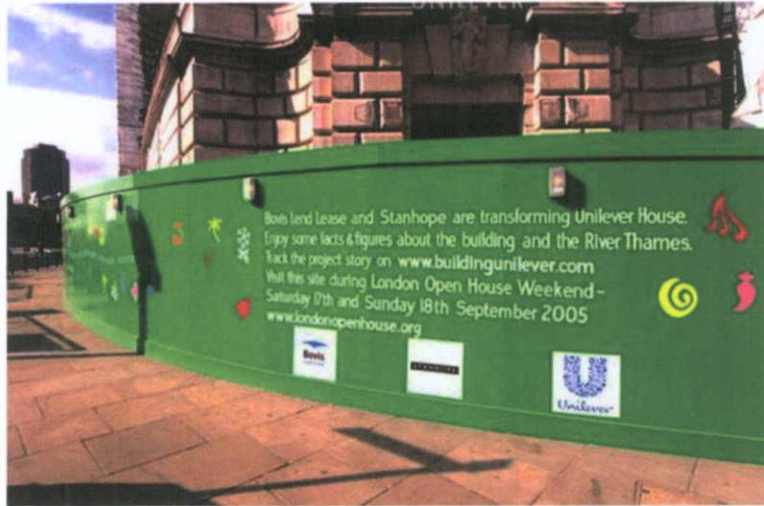

Figure 28. Typical Pavement Hoarding with Street Lighting

Where there are ESB/telecommunication kiosks, light poles and traffic signage on the footpaths these will be maintained by the Main Contractor/Contractors where practical. The hoarding will be constructed around traffic lights and the kiosks to maintain visibility and access to the agreement of Dublin City Council.

5.2 Site 2 Compound

It is proposed to locate the Site 2 compound within the site Masterplan's Site 5 boundary. The compound will consist of:

- Offices
- Meeting Rooms
- Toilet / Shower Rooms
- Drying Rooms
- Canteens
- Storage Containers

All cabins will be steel securi-type with steel lockable shutters to windows and steel lockable door. All cabins will come to site in good condition and will be maintained in good order throughout the project. Double / triple stacking of cabins may be required with safe stairs and walkways provided to the upper levels of offices.

5.3 Access & Egress

Safety and ease of access to the site are to be provided for by the Main Contractor/Contractors when planning the works. Separation of vehicular and heavy plant traffic from pedestrians and operatives will be implemented as far as is practical when considering the layout of the site infrastructure and access points.

Where a site access crossing is required on a pavement this will require a dedicated pedestrian management setup to ensure there are no incidents of crossovers between pedestrians and site vehicles. This may require a turtlegate barrier in addition to with semi-permanent barriers along the kerb edge, flagmen to control barriers and flagmen to watch truck movement and pedestrians.

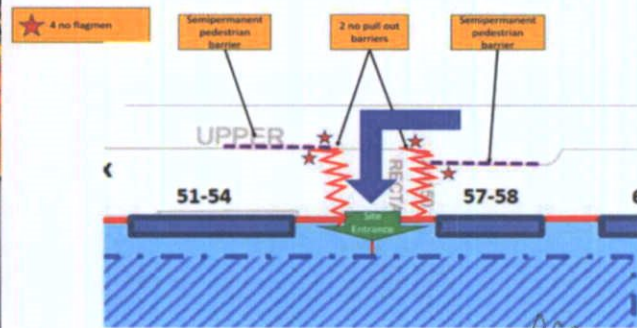

DCC PLAN NO 5126/22
RECEIVED: 26/10/2022

Figure 29. - Typical Pavement Crossover System

5.4 Logistics

Both Block 2AB and Block 2C will require dedicated tower cranes to service the construction activities. This will include all stages of construction including the building envelope and fit-out lifting requirements. These may be complemented with teleporters, mobiles cranes, hoists and mobile concrete pumps as required.

The construction traffic and pedestrian routes are outlined in the Construction Traffic Management Plan. In general, trucks will be off loaded from the designated laydown areas. Deliveries will typically be on a just in time basis and this system will be strictly controlled by Main Contractor/Contractors who will organise the deliveries. The Main Contractor/Contractors will advise their suppliers on the delivery routes, ensuring the drivers are made aware of the site location and the correct route to site in accordance with the Dublin City Council heavy goods vehicles cordon restrictions.

If any plant setups are required outside the site, a road lane closure may be required. The road closure license will be obtained from Dublin City Council and an agreed traffic management plan will be implemented as required. Any traffic management measures will be designed by qualified personnel in accordance with Chapter 8 of the Traffic Signs Manual and implemented by Signing, Lighting & Guarding (SLG) trained operatives.

The logistics plan will be presented to workers during the site induction. Refresher training in the logistics plan will be presented in toolbox talks.

5.5 Proposed Craneage Strategy

Tower cranes will be required during each of the construction phase of the development. The Main Contractor will nominate the location(s) of these once appointed but indicative locations are shown in Appendix A – Proposed Site Setup. Mobile cranes may also be utilised on a short-term basis throughout the construction period.

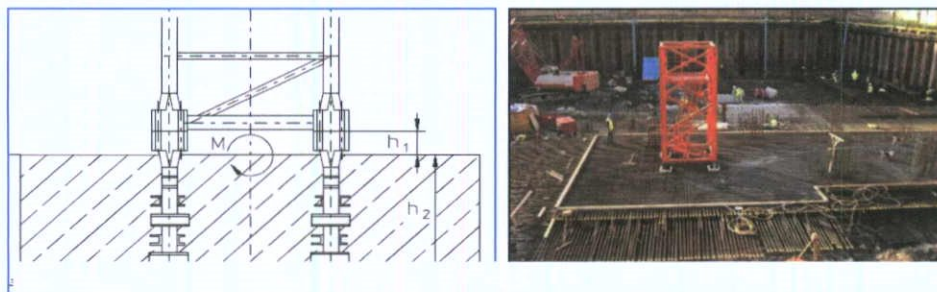

Figure 30. Typical Tower Crane Anchors

5.6 Power, Waste & Drainage

A power supply from ESB Networks to power both the compound and the construction site will be applied for by the Main Contractor/Contractors. The size of supply will be calculated to ensure it is sufficient to power both the site compounds and construction site activities. A dedicated power supply will be provided for the tower cranes, task lighting, power tools and charging stations for plant such as electric hoists.

In the event of any delays securing the required power supply to power offices and cranes, generators may be required. Diesel generators will have sound enclosures and will be regularly serviced to prevent noise and odour pollution and setup in a spill tray to prevent any spillage contaminating the ground. Temporary site lighting will be installed to provide safe and well-lighted walkways around the site compounds and task lighting to the construction sites.

Water and drainage will be required to service the site toilets and canteen facilities. The Main Contractor/Contractors will carry out a site survey to identify the locations of the water and foul drainage connections to each of the sites. It will be the Main Contractor/Contractors responsibility to apply to Irish Water for connections to the water main and foul drain, ideally utilising existing connections.

5.7 Working Hours

The working hours will be dictated by the planning conditions and are expected to be as follows:

Days	Start Time	Finish Time
Monday-Friday	8:00	18:00
Saturday	8:00	14:00
Sunday	No work permitted	No work permitted
Bank or Public Holiday	No work permitted	No work permitted

Working times will be within the hours permitted by the Planning Decision for the development. It may be necessary to work outside these hours at times, for example for early morning concrete pours and late evening concrete finishing. The Contractor will consult Dublin City Council regarding out of hours working and local residents and businesses will be informed of any out of hours works required. A planning derogation will be applied for to Dublin City Council when out of hours working is required. The terms and conditions of the planning derogation will be strictly adhered to at all times.

5.8 Car Parking

In general, there will not be car parking for operatives on site. Personnel will be encouraged and informed of the numerous public transport options available to access the works.

5.9 Wheel Washing Facility Requirement

The Main Contractor/Contractors will ensure that the enabling works package will include provisions for a wheel washing facility with water collection and filtering before any discharge to the public surface water drainage system. Trucks discharging concrete should have a wash out area to clean the chute prior to entering the wheel wash.



Figure 31. - Typical Wheel Washing Facility

5.10 Expected Vehicle Movement

An outline construction traffic management plan has been prepared and details access routes, site signage, haulage license protocols and environmental control procedures. Reference should be made to the Construction Traffic Management Plan submitted as part of the planning documents.

Once the construction programme is finalised by the appointed Main Contractor/Contractors, a detailed breakdown of the expected vehicle movements will be available.

5.11 Security

In addition to the hoard to the Site 2 perimeter the following measures will be adopted by the Main Contractor/Contractors:

- A dedicated site security team with 24hr access to the site and direct contact with the local An Garda Siochana station.
- Each person on site will have been inducted and fingerprint access control will be used for site entry and exit. The Contractor will know who is on site at all times.
- There will be a site CCTV system which may be extended to cover the footpaths and roads around the site (depending on the GDPR regulations).
- Hoarding lighting will be incorporated to increase the general illumination levels around the site.
- Siting the cabins behind the hoarding with windows overlooking the streets will provide a greater degree of natural surveillance to the area to ward against anti-social behaviour.

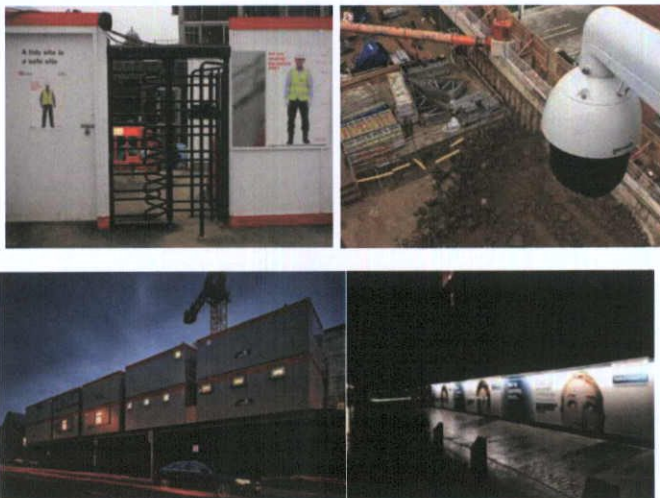

Figure 32. Typical Site Security Measures

5.12 Diaphragm Wall Site Setup

The walls to form the station box are to be constructed using diaphragm walls.

The final construction sequence will be based on the contractors preferred method however the typical construction sequence involves the construction of a shallow guide wall to maintain the setting out and verticality of the main wall. Panels of the diaphragm wall are then excavated using cutting or grabbing machinery. Based on the depth to the Calp Limestone formation, and the proposed levels of the station box, it is assumed a proportion of the excavation will be within the rock and therefore a hydraulic cutting machine is likely to be used.

In order to support the sides of the excavation prior to concreting, a support fluid is pumped into the excavation which exerts a hydraulic pressure against the trench walls and prevents collapse of the side. This is typically a bentonite fluid which can be mixed and stored on site and re-used across multiple excavations. Stop ends are also installed in the trench to produce a defined profiled joint to the next panel. They can also be used to install a water bar if required.

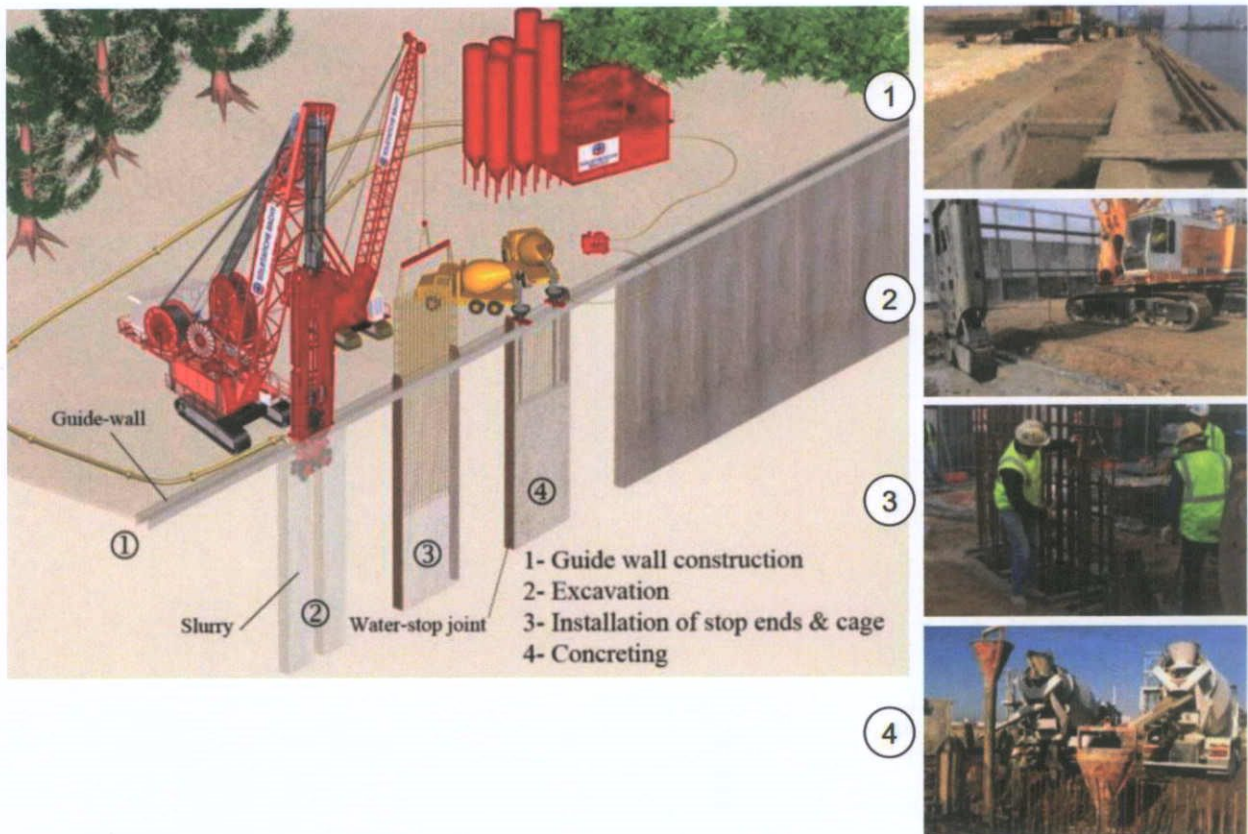

Figure 33. Typical Diaphragm Wall Setup

The prefabricated reinforcement cage is then installed into the trench. The connection points for the curved slab at platform level, and the slabs at the mezzanine, concourse, and capping slab levels can be blocked out within the reinforcement cage to allow for connection at the relevant point of the construction sequence. Concrete is then poured into the trench, typically through tremie pipes that extend to the bottom of the trench and fill from the bottom up. The support fluid is displaced as the concrete is pumped into the trench and can be re-use in other excavations for the wall.

Panel construction progresses in a hit and miss sequence. This aids the construction programme as excavation can commence on other panels while the previously completed panel cures. Once a panel has cured, the adjacent panel can be excavated, the stop end from the initial panel removed, and the casting sequence noted above repeated to form the adjacent connected panel.

The drilling suspension fluid, typically bentonite slurry, will be contained and stored within reservoir tanks located on site adjacent to the operation. During placement of the concrete via tremie pipe method the suspension slurry will be recycled and recirculated back to the reservoir tanks using pumps. The Contractor's methodology will be required to minimise spillages during construction of the diaphragm wall. The area will be kept clean with bunds placed around the operation to prevent the spillage of support fluid. The Contractor's detailed methodology will also address any spillages which will need to be immediately contained. Contaminated soil will be removed from site and disposed of in a licenced waste facility. The cleaning procedure as well as the time between operations shall be established by the Contractor ahead of the works commencing.

Section 5.12 Diaphragm Wall Site Setup contains further information on the diaphragm wall construction.

6. Protection of Retained Structures during Construction

6.1 Existing Buildings

Site 2 is occupied by a variety of 3 and 4 storey buildings which mainly comprise retail units at ground floor along O'Connell Street Upper with offices above. Block 2AB incorporates the retained facades to 57-58 O'Connell Street Upper and the rear building to 59 O'Connell Street Upper also known as the "Reading Room". Block 2C incorporates the retained facades to 43-45 O'Connell Street Upper and 52-54 (Carlton Façade) O'Connell Street Upper.

Of particular importance to the Site 2 development are the retained facades and buildings of historical importance and the adjoining buildings to the site.

Retained facades within Site 2 (above Ground Floor) include:

- 43-45 O'Connell Street Upper
- 52-54 (Carlton Façade) O'Connell Street Upper
- 57-58 O'Connell Street Upper

Other retained buildings of historical importance currently proposed within the site development include:

- 59-60 O'Connell Street Upper rear building "Reading Room"
- 61 O'Connell Street Upper (Protected Façade)

Buildings Adjacent to Site 2 of historical importance include:

- 42 O'Connell Street Upper & O'Connell Hall (protected)
- 59 O'Connell Street Upper ("Reading Room")

Nearby Building to Site 2 include:

- General Post Office (National Monument)
- 14-17 Moore Street (National Monument)

At the next stage of the project, where structures are to be retained and conserved, intrusive structural investigations will be undertaken to provide a greater understanding of the existing condition and arrangement of the structure. This will also include neighbouring buildings if access can be provided. This will include a visual structural inspection with the finishes removed and sampling and testing of the structural fabric to test for strength and material properties.

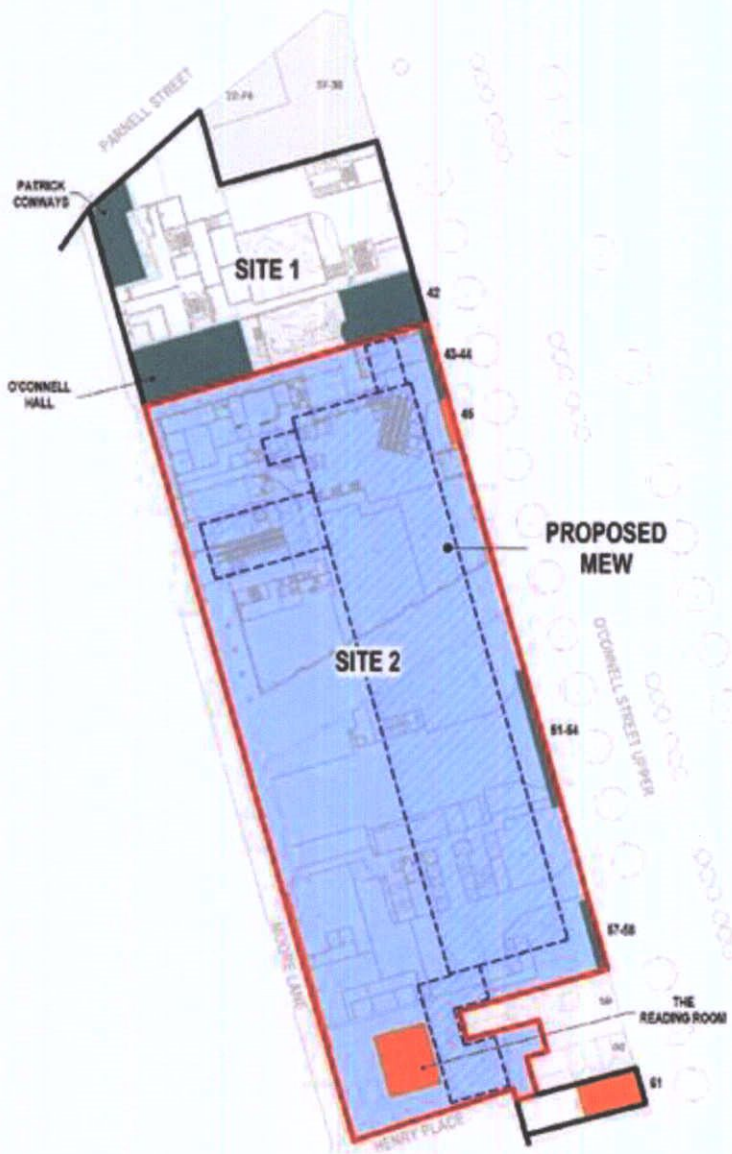

LEGEND

- MASTERPLAN SITE BOUNDARY
- SITE BOUNDARY
- NATIONAL MONUMENT (UNDER STATE OWNERSHIP)
- PROTECTED STRUCTURE / FACADE
- RETAINED STRUCTURE / FACADE

Figure 34. Site 2 Protected and Retained Structures

6.2 14-17 Moore Street - National Monument

Moore Lane and Nos 14-17 Moore Street are located outside of the western boundary of Site 2. A construction access haul road is also proposed along the line of Moore Lane.

The design concept for the basement and the support of Moore Lane and the Moore Street properties beyond the boundary of Site 2 has been carefully considered. Limiting ground movement is an important consideration and preliminary analysis has been undertaken and is presented in the Basement Impact Assessment report included as part of the planning submission. The proximity of the National Monument to the excavations and construction vehicles is a key factor in considering the demolition and temporary and permanent earthworks support along the Site 2 Moore Lane boundary. To address the sensitivity of the National Monument the planning stage design concepts provide a stiff temporary and permanent works solution along the Moore Lane boundary. There will be further ground movement and phasing analysis undertaken at the following design stages in collaboration with and taking account of the main contractors method statements and programme for the works. The final design of the secant piled walls and the temporary works propping will be provided by the appropriate specialist sub-contractors.

It is proposed to construct a secant piled wall along the western boundary of Site 2. In the temporary condition the secant piled wall retains the soil outside the site boundary, the stiffness of the wall will be designed to reduce ground movement associated with the basement excavation works. Additionally, the secant piled wall provides protection to the construction works within Site 2 from the surcharge loading of construction traffic along the haul road. In the permanent design, the secant wall forms the basement of Site 2.

The secant piled wall at the boundary is part of the strategy for enabling the deeper excavation to form the MEW station box. The shallow basement required for the oversite is less significant than the deep basement excavation that are required to enable the MEW station box.

The MEW works are to be excavated between parallel diaphragm walls which will be propped across the excavation as work proceeds to limit the wall deflection and thereby limit the ground displacement. The propping may also need to incorporate jacks to prestress the props to further control and limit ground movement. This will be considered further with the relevant contractors and incorporated into their construction methodology.

In addition, two additional piled walls will be located a short distance away from the diaphragm walls, these ultimately support the building loads from the super structures above, but in this temporary case they also add further to the ground stiffness and contribute to managing lateral soil movement and hence the impact on Moore Lane and the nearby Moore Street properties.

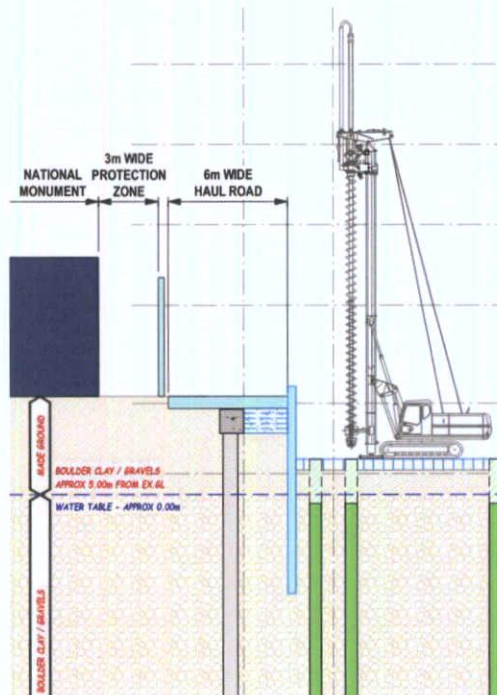

Figure 5. Section Through the National Monument, Moore Lane, and the Western Boundary of Site 2

6.3 Site 2 – Retained Facades

Particular consideration has been given to the retained and/or protected structures on or adjacent to Site 2. These shall be protected during demolition and construction via extensive temporary works required throughout the development that will be coordinated and incorporated into the permanent works. The following proposed retention systems outlined in this report are for guidance purposes only and will be subject to site investigations of the existing conditions and design by the Temporary Works Specialists.

The existing facades above ground floor at Nos. 43-45, 52-54 (Carlton Cinema Façade), and 57-58 O'Connell Street Upper are protected and are to be retained in the proposed development.

6.3.1 Structural Assessment

Prior to commencing demolition each façade that is to be retained will be inspected for signs of historic structural movement or structural distress. This will include the external face and internal surfaces. To be able to inspect the structure internally the existing finishes will need to be removed to expose the structure of the wall.

If there are steel beams embedded in the wall the condition of these will be inspected to ensure that the beam is not significantly corroded due to moisture ingress. If deterioration is evident and is beyond repair a strategy for replacement or removal will be developed.

Lintels over doors and windows will also be examined. Timber lintels will be replaced with a suitably durable replacement at an appropriate time during the reconstruction works. Steel beams and lintels will be examined and where suffering from corrosion or damage will be repaired during the re-construction works.

It is likely that some brick work may be loose or missing and the internal surface once exposed may be irregular with “pockets” or voids where bricks may have been removed over the lifetime of the building. Where this is the case, these voids will be infilled with brickwork to reinstate the thickness of the wall.

6.3.2 Temporary Condition

The retained façades will require lateral support which will need to be in position prior to demolition of the building behind. Existing internal finishes will be removed to reveal the structural elements of the wall. The existing windows will be removed, and the window openings will be temporarily reinforced with timber bracing. As demolition proceeds the rear of the façade will be covered with felt and battens to protect the façade from exposure to weather and general construction activities. The front of the façade will be covered by a suitable sheeting that will also provide a degree of weather protection and will extend over the façade retention system. This strategy will be developed further during the detailed design stages and will be conveyed to the main contractors at tender and taken through into construction stages.

6.3.3 Temporary Condition – 43-45 O’Connell Street Upper

The retained façade to 43-45 O’Connell Street Upper will require lateral support which will need to be in position prior to the demolition of the building behind. The concept for this is to provide a steel frame on the wide O’Connell Street Upper footpath with the columns supported on concrete kentledge blocks.

Where the bases are located over existing pavement vaults, these will be suitably back-propped and protected. The façade retention system shall incorporate a suitable protective structural deck above the “passageway” beneath the temporary structure should pedestrian access need to be maintained at pavement level. Site cabins may be located within the façade retention system above first floor level subject to the Main Contractor’s logistics plans.

The façade retention details for 43-45 O’Connell Street are shown in Appendix C.

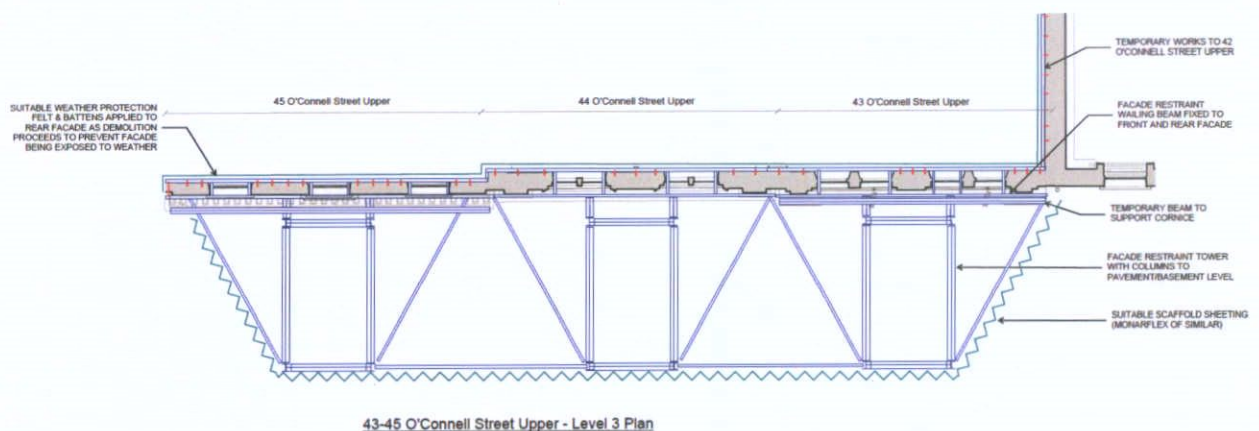

Figure 36 – 43-45 O’Connell Street Upper (Plan – Typical Façade Restraint System)

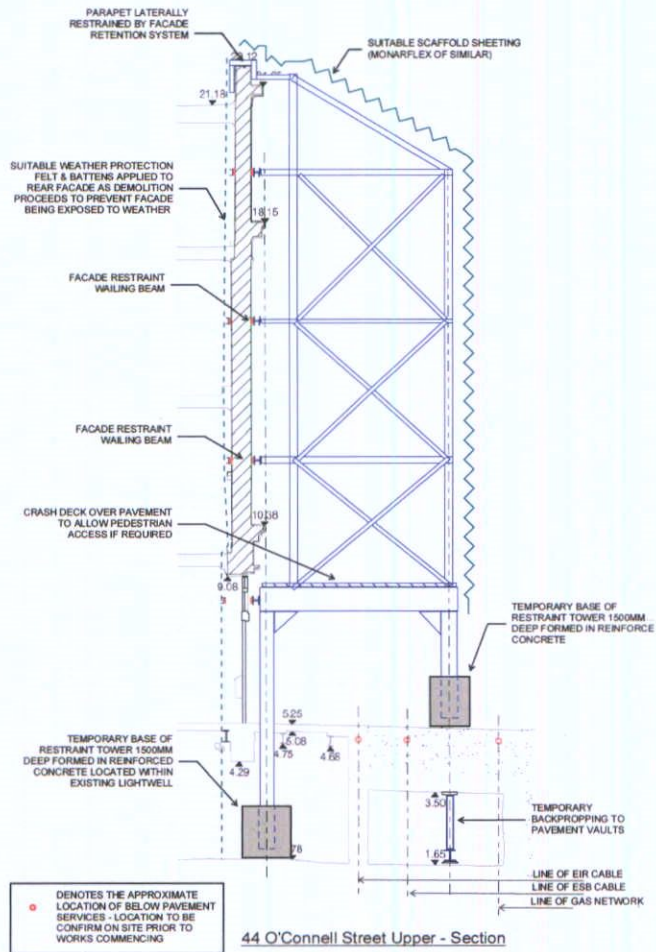

Figure 37 – 43-45 O'Connell Street Upper (Section – Typical Façade Restraint System)

6.3.4 Retained Facades – 52-54 O’Connell Street Upper

The retained façade to 52-54 O’Connell Street Upper will be provided with a similar system of support and the same approach will be adopted to safeguard the façade. The façade retention details for 52-54 O’Connell Street are shown in Appendix C.

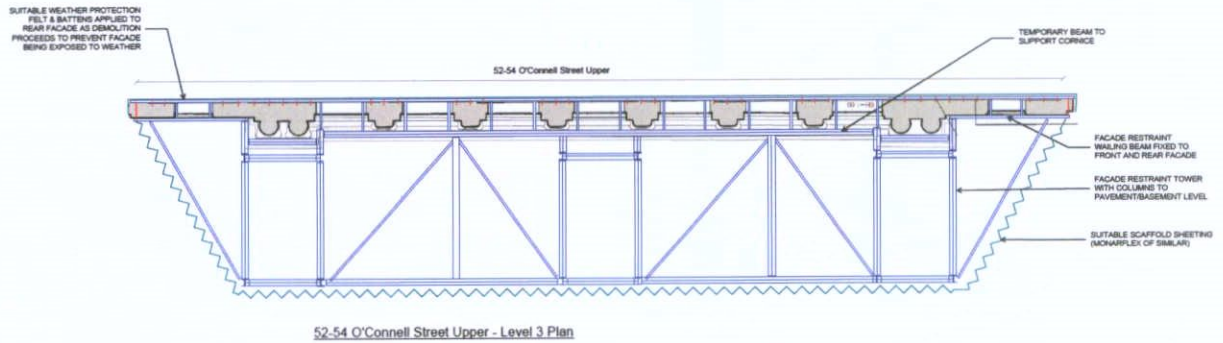

Figure 38 – 52-54 O’Connell Street Upper (Plan – Typical Façade Restraint System)

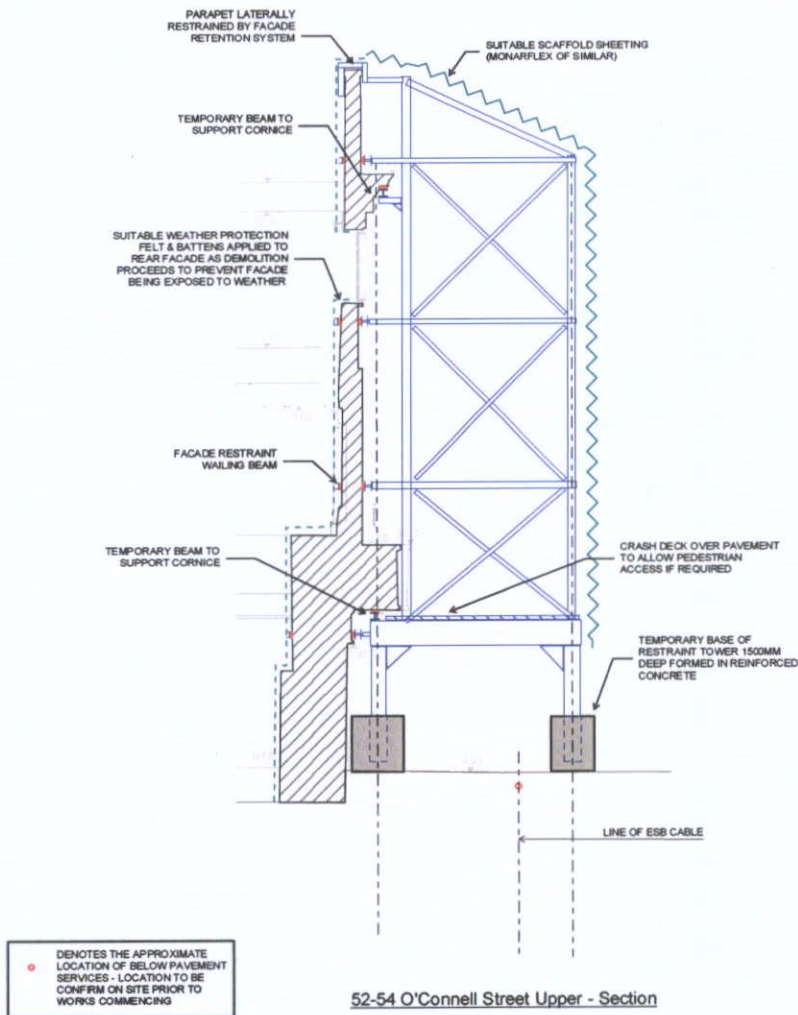

Figure 39 – 52-54 O’Connell Street Upper (Section – Typical Façade Restraint System)

6.3.5 Retained Facades – 57-58 O’Connell Street Upper

The retained façade to 57-58 O’Connell Street Upper will be provided with a similar system of support and the same approach will be adopted to safeguard the façade. The façade retention details for 57-57 O’Connell Street are shown in Appendix C.

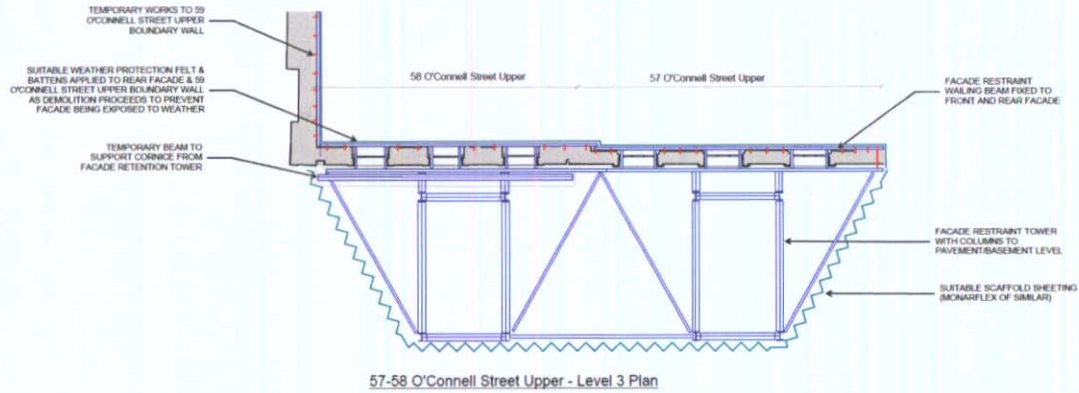

Figure 40 – 57-58 O’Connell Street Upper (Plan – Typical Façade Restraint System)

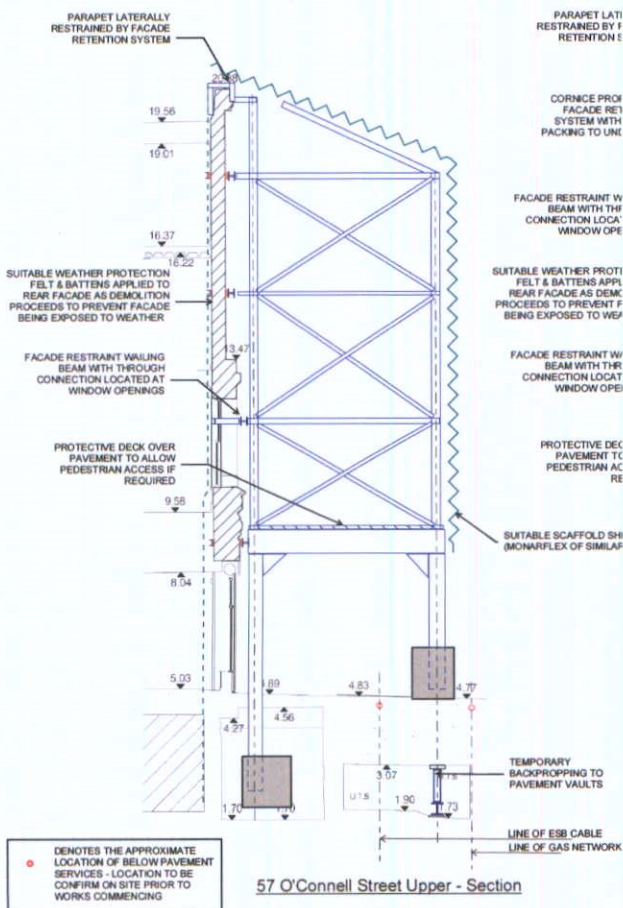

Figure 41 – 57-58 O’Connell Street Upper (Section – Typical Façade Restraint System)

6.4 Adjoining Buildings

At the northern end of Block 2C, the site shares a boundary with the protected structures at 42 O'Connell Street Upper and O'Connell Hall. This building is not included in the Site 2 application but the boundary condition needs to be considered in our design.

At the Southern site boundary a similar condition will apply at 58 O'Connell Street.

6.4.1 Structural Assessment

42 O'Connell Street Upper O'Connell Hall is currently bookended by No 43 O'Connell Street Upper and is part of a terrace of buildings. On the North side of No 42 the former buildings have been demolished some years ago and No 42 North flank wall is currently braced by temporary steel framed raking shores. O'Connell Hall is similarly propped but flying shores exist propping the North flank wall. These temporary works were installed by the previous site owners as part of the previous redevelopment plans.

A similar condition exists at 58 O'Connell Street Upper and will need to be safeguarded during the course of the works.

6.4.2 Temporary Condition

During the demolition and reconstruction phase of Site 2 temporary support will be required to the exposed Southern flank walls of No 42, the linking structure and O'Connell Hall, raking shores will need to be provided inside No 42 O'Connell Street and the existing shoring to the North Boundary will also need to be retained. Alternatively if work can be undertaken inside No 42 O'Connell Street Upper and O'Connell Hall in parallel with or in advance of the Site 2 demolition to make these adjoining structures independently stable, the temporary raking shores within Site 2 and to the North boundary may be able to be avoided. The raking shores will be supported on temporary pad foundations located below the level of the proposed basements. Localised temporary works will be required to protect the existing foundations for 42 O'Connell Street Upper while the local bases are installed.

Once the temporary raking props have been installed and as demolition progresses the exposed party/boundary walls will be protected from the weather using felt and battens.

58 O'Connell Street Upper is not owned by DCGP Ltd and so the temporary works will need to be discussed with the adjoining owners, any temporary works shoring will need to be positioned inside Site 2.

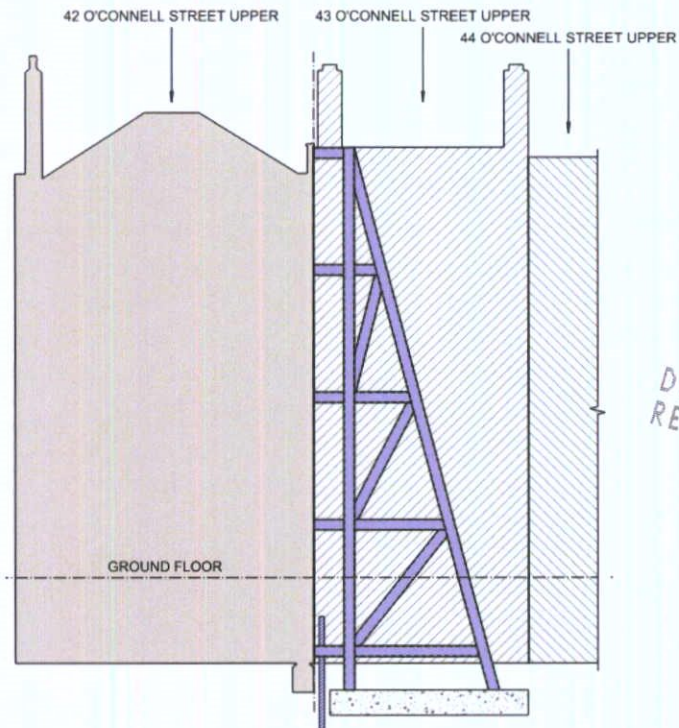

Figure 42. Indicative Temporary Works Scheme for 42 O'Connell Street Upper Installed within No. 43 – a similar system is proposed at 50 O'Connell Street Upper boundary

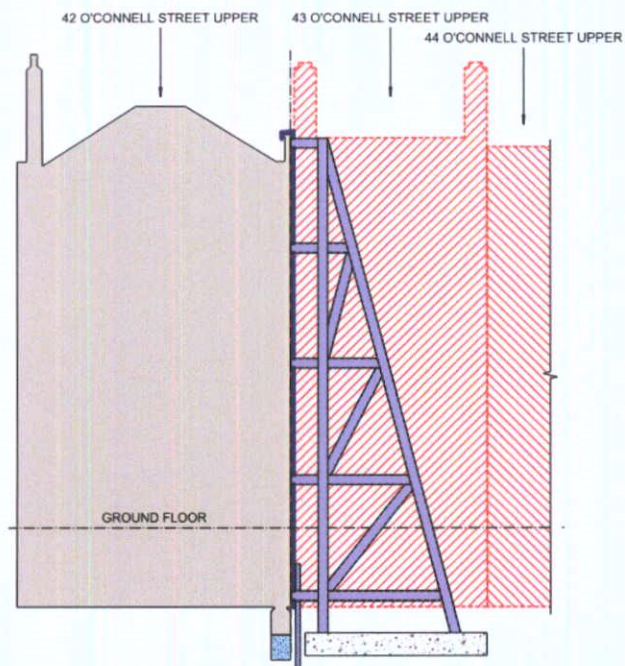

Figure 43. Exposed Face of 42 O'Connell Street Upper Party Wall Protected as No.43 is Demolished

Monitoring will be undertaken for movement and vibration during demolition and construction and permissible thresholds will be agreed with the contractors

6.5 Site 2: Basement Impact Assessment

The Basement Impact Assessment (BIA) including a Ground Movement Analysis Assessment undertaken by Waterman is included as part of the planning documents.

The Ground Movement Analysis considered each stage of the development including demolition, piling, bulk excavation, and construction of each site of the development. Particular consideration has been given to the retained and/or protected structures on or adjacent to the site, including the National Monument, 42 O'Connell Street Upper, and O'Connell Hall. Details of the temporary measures to protect these structures are provided in the Outline Construction Management Plan for Site 2.

The Ground Movement Analysis assesses the predicted potential impact of the proposed development to the adjacent buildings and retained structures within the site. A building damage assessment was used in accordance with CIRIA C760 'Criteria of building damage assessment'.

The report concludes that the potential damage for all protected structures and retained façades remains at categories range of Category 0 'Negligible' to Category 1 'Very Slight' damage during all construction stages. The potential impacts of Site 2 works are in accordance with DCC Guidance, and therefore, can be considered as acceptable. The predicted movement results for the Luas light rail tracks do not show any onerous conditions for the assets and the calculated movements are below the limits proposed by the Code of engineering practice for works on, near, or adjacent the Luas light rail system. Therefore, the proposed Site 2 works do not highlight any concern to affect the day-to-day operations.

6.6 Movement Monitoring of Retained and Existing Structures

6.6.1 Overview

Prior to demolition of the existing building, an external survey control system is to be established around the site, including all protected structures, retained buildings, retained facades and the National Monument.

This will be carried out using either traditional closed traverse surveying techniques or continuous automated total station (AMTS) monitoring of movement, depending on the sensitivity of the existing buildings and proposed method of construction/demolition. The form of monitoring will be subject to the condition of the existing structures following site surveys. The Contractor will ensure there are sufficient external control stations to allow for the continuous monitoring of the structures during and after demolition and throughout the construction stage.

The monitoring regime shall have co-ordinates which are directly correlated to the building grids and datum levels related to those shown on the Land Survey drawings, issued by the Architect. An initial control survey is to be carried out by the Contractor and may be independently checked and verified by the appointed survey contractor.

The targets will consist of reflective optical survey targets (typically prisms) that shall be adhered to the external surface of the retained structures and neighbouring buildings. The target locations shall be agreed with the relevant parties and the target adhesive shall be tested to demonstrate that no damage will be caused to the existing building fabric surface upon removal of the targets.

6.6.2 Proposed Monitoring Regime

The retained structures and neighbouring buildings shall be continuously monitored for changes in vertical and lateral movement with real-time data available. The monitoring of movement will be

measured against trigger levels with direct alerts (via email/SMS text) sent from the system to nominated persons.

The results shall be measured with co-ordinates in eastings, northings and elevation (E, N, Z) established. A minimum number of baseline co-ordinates shall to be recorded and checked for control purposes 2 weeks prior to commencement of the demolition works. The results are to be recorded and the directional change and quantum movement from the controls and previous readings calculated.

Proposed Trigger Level	Movement (mm)
Green	Less than 12
Amber	Between 12 and 15
Red	Greater than 15

Table 4 – Proposed Movement Trigger Levels

Unless otherwise agreed, movements of any target position equal to or greater than 12mm from baseline readings shall trigger 'amber' and shall be addressed by the Contractor. The Contractor shall advise the Engineer on the reason for the movement and advise his proposals to control further movement.

Movements of any target equal to or greater than 15mm from baseline readings shall trigger 'red' where immediate action is required by the Contractor. The Engineer and Contract Administrator shall be notified immediately.

7. Control and Monitoring of Noise, Vibration and Dust on site

7.1 Condition Surveys

It will be necessary to carry out a detailed condition survey of all adjoining lands and properties prior to any works commencing on site, with particular attention paid to the protected structures noted previously in this report. In addition, baseline movement monitoring will be carried out in line with best practice.

7.2 Noise Monitoring

The contractor will deal with the immediate dangers to hearing etc. associated with high noise levels and the impact of same on construction operatives by means of risk assessment and mitigation / precautionary measures and equipment, all in full compliance with the current Health and Safety legislation.

Noise on site shall comply with Safety, Health and Welfare at work (construction) Regulations 2006 to 2013, Safety, Health and Welfare at Work Act 2005, BS 6187:2011 - Code of Practice for full and partial demolition, BS 5228:2009+A1:2014 Parts 1 & 2 - Code of Practice for noise and vibration control on construction and open sites – Vibration, Environmental Protection Agency Act 1992 Sections 106-108, including all Local Authority specific requirements for this specific site.

A survey of baseline noise and vibration will be undertaken to gain an understanding of the typical range of the existing conditions in the surrounding area. Methods of minimising construction noise and vibration will be implemented where possible. The Main Contractor is to implement these recommendations and utilise the most efficient construction methods to reduce the impact on the neighbouring environment.

The nature of construction activities means that a certain level of noise is inevitable, but the appointed Main Contractor must endeavour to minimise this as far as practically possible and reduce the effect and any nuisance to the surrounding environment and neighbours.

Work methods are to be reviewed to ensure minimal noise and vibration are created; methods should include:

- Each item of plant used on site complies with the noise limits quoted in the relevant European Commission Directive 2000/14/EC/ [S.I. No. 632 of 2001].
- All plant and equipment liable to create noise whilst in operation will, as far as reasonably practicable, be located away from sensitive receptors and neighbouring occupied buildings.
- The use of barriers and hoarding to absorb and/or deflect noise away from noise sensitive areas will be employed where required and reasonably practicable.
- All plant, equipment and noise control measures applied to plant and equipment shall be maintained in good and efficient working order and operated such that noise emissions are minimised as far as reasonably practicable. Any plant, equipment or items fitted with noise control equipment found to be defective shall not be operated until repaired.
- Fixed items of construction plant shall be electrically powered in preference to diesel or petrol driven. The Main Contractor shall ensure that vehicles and mechanical plant employed for any activity associated with the construction works will, where reasonably practicable, be fitted with effective exhaust silencers.
- Machines in intermittent use shall be shut down or throttled down to a minimum during periods between works. Static noise emitting equipment operating continuously will be housed within suitable acoustic enclosures, where appropriate.
- Tower cranes will be utilized instead of crawler cranes as these are electrically powered and quieter in operation.
- Noise suppression hammers and shields will be used on rock breaking equipment.

- Working hours will be confined to those stipulated in the grant of planning permission.
- Noise emitting processes such as rock breaking can be suspended during sensitive hours, to be agreed in consultation with DCC and neighbours.
- Alternative work practices will be investigated where the noise emitted is reduced (for example prefabricating building components off site).
- Site deliveries will be confined to working hours and allocated offloading location will be utilized for all deliveries.
- The Site Manager will also continually review and monitor the noise / dust / vibration levels / risk throughout the duration of the project and if necessary, adjust / add to the control measures to be employed to reduce nuisance.

7.2.1 Measures to Mitigate Noise

Of particular consideration is the noise from construction activities adjacent to the public footpaths and commercial areas (Moore Street, Henry Street and O'Connell Street Upper). Noise mitigation measure will be proposed by the Contractor and may include:

1. The installation of a solid timber hoarding to provide noise insulation.
2. A high-level acoustic wrap applied to the scaffolding to provide some degree of noise barrier.
3. Particularly noisy works can have an acoustic noise control barrier put around them when the works are being carried out.
4. When jack hammers are used a "no racket" jacket will be applied which reduced the noise by up to 10db when 50ft away.



Figure 44 – Typical Noise Mitigation Measures

7.3 Vibration

During the course of the work proposed at Site 2 Ground borne vibrations from the proposed works could give rise to adverse effects to the Heritage Structures / Protected Structures / National Monument and these control measures are to be put in place during the works to ensure protection of the structures and finishes.

7.3.1 Proposed works and potential risks

The proposed works involve excavations; piling works and general construction works of basements, multi-storey framed building and repairs to the historic structures / protected structures themselves immediately adjoining.